

Vitocal 100-A

Model AWO(-M) 101.A06 up to A18

Air/water single block heat pump

Model AWO(-M)-AF 101.A06 up to A18

Air/water single block heat pump with built-in antifreeze kit



VITOCAL 100-A



This manual has been drawn up for informative purposes. The company disclaims any liability for the results of any design or any installation based on the explanations and on the technical specifications provided in this manual. Even the partial reproduction of the texts and figures in this manual is prohibited under any form. Translation of original manual. The data in this manual are not binding and can be changed by the manufacturer without prior notice
Even partial reproduction PROHIBITED © Copyright

CONTENTS

1	PURPOSE AND CONTENTS OF THE MANUAL	5
1.1	HOW TO KEEP THE MANUAL	5
1.2	GRAPHIC SYMBOLS USED IN THE MANUAL	5
2	NORMATIVE REFERENCES	6
3	PERMITTED USE	6
4	GENERAL SAFETY GUIDELINES	7
4.1	WORKERS' HEALTH AND SAFETY	7
4.2	PERSONAL PROTECTIVE EQUIPMENT	8
4.3	SAFETY SIGNS	8
4.4	REFRIGERANT SAFETY DATA SHEET	9
4.5	SPECIFIC R32 GAS WARNINGS	10
4.6	R32 GAS CHARGE	11
4.7	R32 GAS DISPOSAL	11
4.8	SAFETY RULES FOR R32 GAS TRANSPORT AND STORAGE	11
5	INSTALLATION	11
5.1	GENERAL	11
5.1	TRANSPORT AND STORAGE LIMIT TEMPERATURE	12
5.2	LIFTING AND HANDLING	12
5.2.1	<i>Lifting mode</i>	12
5.3	POSITIONING AND MINIMUM TECHNICAL CLEARANCES	13
5.4	DIMENSIONS	16
5.4.1	<i>Model Vitocal 100-A 06 / 08</i>	16
5.4.2	<i>Model Vitocal 100-A 10 / 12</i>	16
5.4.3	<i>Model Vitocal 100-A 14 / 16 / 18</i>	17
5.5	ACCESSING THE INNER PARTS	18
5.5.1	<i>Mod. Vitocal 100-A 06 / 08</i>	18
5.5.2	<i>Mod. Vitocal 100-A 10 / 12</i>	18
5.5.3	<i>Mod. Vitocal 100-A 14 / 16 / 18</i>	19
5.6	PLUMBING CONNECTIONS	19
5.6.1	<i>Features of the circuit water</i>	20
5.6.2	<i>Typical plumbing diagram</i>	21
5.6.3	<i>Handbook</i>	21
5.6.4	<i>Condensation discharge system</i>	21
5.6.5	<i>Filling the system</i>	22
5.6.6	<i>Discharge of the plant</i>	22
5.6.7	<i>Service sleeves</i>	22
5.6.8	<i>Air venting valve</i>	23
5.6.9	<i>Vitocal 100-A 06 / 08</i>	24
5.6.10	<i>Vitocal 100-A 14 / 16 / 18</i>	26
5.7	ELECTRICAL CONNECTIONS	27
5.7.1	<i>Access to the electric panel</i>	27
5.7.2	<i>Power supply terminal block</i>	28
5.7.3	<i>User terminal block</i>	29
5.7.4	<i>Control logics</i>	32
5.7.5	<i>Fuses</i>	32
6	STARTUP	32
6.1	SWITCHING ON THE UNIT	33
7	INSTRUCTIONS FOR THE USER	33
8	SHUTDOWNS FOR LONG PERIODS	33
9	MAINTENANCE AND PERIODIC CHECKS	34
9.1	CLEANING THE FINNED COIL	35
9.1.1	<i>Cleaning the finned coils with the anti-corrosion method</i>	35
9.1	CLEANING OF EXTERNAL SURFACES	36
9.2	EXTRAORDINARY MAINTENANCE	36

10	DECOMMISSIONING	36
10.1	RESIDUAL RISKS.....	37
11	TECHNICAL DATA.....	44
11.1	TECHNICAL SHEET	44
11.2	UNIT AND AUXILIARY ELECTRICAL DATA	46
12	OPERATING LIMITS.....	46
12.1	EVAPORATOR WATER FLOW RATE	46
12.2	COLD WATER PRODUCTION (SUMMER MODE).....	47
12.3	HOT WATER PRODUCTION (WINTER MODE)	47
12.4	AMBIENT AIR TEMPERATURE AND SUMMARISED TABLE	47
13	USER INTERFACE - CONTROLLER.....	50
13.1	MENU	51
13.2	SETPOINT MENU.....	51
13.3	ALARMS MENU [ERR].....	51

The manual of the Vitocal 100-A units contains all the necessary information for optimal use of the equipment under safe conditions for the operator.

1 PURPOSE AND CONTENTS OF THE MANUAL

This manual provides basic information as to the selection, installation, operation and maintenance of the Vitocal 100-A unit. It is intended for the operators of the appliance and it enables them to use the equipment efficiently, even if they do not have any previous specific knowledge.

	<i>CAUTION: Although this manual has been drafted for the end user, some of the operations described are the responsibility of skilled personnel having technical or professional qualifications to perform the activities herein. They must also be kept up-to-date by attending refresher courses acknowledged by the competent authorities. These tasks include: installation, routine and extraordinary maintenance, decommissioning of the appliance and any other operation indicated "by qualified personnel".</i>
	<i>When the installation and/or maintenance operations are over, the qualified operator must correctly inform the end user regarding use of the appliance and the necessary periodical inspections.</i>
	<i>The operator has the responsibility of submitting all of the documentation necessary (including this manual) and of explaining that it all must be kept with care, in the vicinity of the appliance and always available.</i>

The manual describes the machine at the moment it was sold. It must therefore be considered adequate with respect to the state-of-the-art in terms of potentiality, ergonomics, safety and functionality.

The company also performs technological upgrades and does not consider itself obliged to update the manuals of previous machine versions which could even be incompatible. Therefore make sure to use the supplied manual for the installed unit.

The user is recommended to follow the instructions contained in this booklet, especially those concerning safety and routine maintenance.

1.1 HOW TO KEEP THE MANUAL



The manual has to always be kept together with the unit it refers to. It has to be stored in a safe place, away from dust and moisture. It must be accessible to all users who shall consult it any time they are in doubt on how to operate the equipment.

The company reserves the right to modify its products and related manuals without necessarily updating previous versions of the reference material. We also decline any responsibility for possible inaccuracies in the manual if due to printing or transcription errors.

The customer shall store any updated copy of the manual or parts of it delivered by the manufacturer as an attachment to this manual.

The company is available to give any detailed information about this manual and to give information regarding the use and the maintenance of its own units.

1.2 GRAPHIC SYMBOLS USED IN THE MANUAL

	<i>Indicates operations that can be dangerous for people and/or disrupt the correct operation of the unit</i>
	<i>Indicates prohibited operations.</i>
	<i>Indicates important information that the operator has to follow in order to guarantee the correct operation of the unit in complete safety.</i>

2 NORMATIVE REFERENCES

Vitocal 100-A units have been designed in compliance with the following directives and harmonized standards on the safety of machinery:

- EC directives, 2014/35/UE, 2014/30/UE, 2011/65/UE, 2012/19/UE, 2014/68/UE
- Standard UNI EN 12735-1
- Standard IEC EN 60335-1, IEC EN 60335-2-40
- Standards IEC EN 55014-1, IEC EN 55014-2,
- EN 50581
- EN 14276

And the following directives, regulations and standards on ecodesign and energy labelling:

- Community directive 2009/125/EU and subsequent transposal
- Community directive 2010/30/EU and subsequent transposal
- EU Regulation n.811/2013
- EU Regulation n.813/2013
- EN 14511-1:2018. EN 14511-2:2018. EN 14511-3:2018. EN 14511-4:2018
- EN 14825:2018

3 PERMITTED USE

- The company excludes any contractual and extra contractual liability for damage caused to persons, animals or objects, by incorrect installation, setting and maintenance, improper use of the equipment, and the partial or superficial reading of the information contained in this manual.
- These units are built for the heating and/or cooling of water. Any other use not expressly authorised by the manufacturer is considered improper and therefore not allowed. The fluid to use is exclusively water or water and glycol mixture in case of low water temperatures.





It is absolutely NOT allowed to connect the heated water supply from the UNIT directly to the taps of the domestic hot water circuit. This fluid is not intended for sanitary use and must not be ingested

- The installation place and the water and electric circuit must be established by the plant designer and must take into account both technical requirements as well as any applicable local laws and specific authorisations.
- All the work must be executed by skilled and qualified personnel, competent on the existing regulations in country of installation.
- This appliance is intended to be used by expert or trained operators in shops, light industry and in factories, or for commercial use by non-expert personnel.
- The appliance may be used by children at least 8 years old and by persons with reduced physical, sensory or mental capabilities or without experience or the necessary knowledge as long as they are supervised or after them, themselves have received instructions on the safe use of the appliance and understand the relevant dangers. Children must not play with the appliance. Children without supervision cannot do the cleaning and maintenance, which the user is expected to carry out on the unit.
- Direct interaction with the device by people with electrically controlled medical devices, such as pacemakers, is forbidden, as harmful interference may be created. It is recommended to keep adequate distance from unit installation, as indicated by the medical system used.





4 GENERAL SAFETY GUIDELINES

Before starting any type of operation on the Vitocal 100-A units, every operator must be perfectly familiar with the operation of the machine and its controls, must have read, and understood all the information in this manual.

	<i>It is strictly forbidden to remove and/or to tamper with any safety device.</i>
	<i>Children or unassisted disabled persons are not allowed to use the appliance.</i>
	<i>Do not touch the appliance when barefoot or parts of the body are wet or damp.</i>
	<i>It is forbidden to perform any cleaning operation when the master switch is 'ON'.</i>
	<i>It is forbidden to pull, detach or twist the appliance's electric cables, even if unplugged.</i>
	<i>Do not step on, sit down on and/or place any type of object on the appliance.</i>
	<i>Do not spray or pour water directly on the unit.</i>
	<i>Do not dispose of, abandon or leave within reach of children packaging materials (cardboard, staples, plastic bags, etc.) as they may represent a hazard.</i>
	<i>Any routine or extraordinary maintenance operation must be carried out with the machine stopped and disconnected.</i>
	<i>Do not place your hands or introduce screwdrivers, spanners or any other tools on moving parts.</i>
	<i>The machine operator and maintenance personnel must receive suitable training for the performance of their tasks in safety.</i>
	<i>Operators must know how to use personal protective equipment and the accident-prevention rules of national and international laws and regulations.</i>

4.1 WORKERS' HEALTH AND SAFETY

The European Union has issued some directives regarding the safety and health of workers, including: 89/391/EEC, 89/686/EEC, 2009/104/EC, 86/188/EEC and 77/576/EEC and subsequent amendments which every employer is obliged to follow and have followed. We observe therefore that:

	<i>Do not tamper with or replace parts of the unit without the specific consent of the manufacturer. The manufacturer shall have no responsibility whatsoever in case of unauthorised operations.</i>
	<i>Using components, consumables or spare parts that do not correspond to those recommended by the manufacturer and/or listed in this manual may be dangerous for the operators and/or damage the unit.</i>
	<i>The operator's workplace has to be kept clean, tidy and clear of objects that may hinder free movement. Appropriate lighting of the work place shall be provided so as to allow the operator to carry out the required operations safely. Poor or excessive lighting can cause risks.</i>
	<i>Ensure that work places are always adequately ventilated and that the extraction systems are working, in good condition and in compliance with the requirements of the laws in force.</i>
	<i>In the design phase, the indications contained in UNI EN ISO 14738 regarding workstations on the machinery were followed and the lifting limits imposed by UNI ISO 11228-1 were evaluated. Make sure to maintain, during the installation and maintenance of the unit, a posture that does not cause fatigue. Check the weight, before moving any component.</i>

The unit works with R32 refrigerant, which is included in the list of greenhouse gases (GWP 675) which are subject to the requirements in EU regulation n. 517/2014 called "F-GAS" (mandatory in the European zone). Among the provisions of this regulation, it sets forth that operators working on systems running with greenhouse gases be in possession of a certification, issued or acknowledged by the competent authorities, attesting that they have passed a test authorising them to perform this work. In particular

- Up to 3kg total refrigerant in the appliance: category 2 certification.
- 3kg and more total refrigerant in the appliance: category 1 certification.

The gaseous form of R32 refrigerant is heavier than air and if released into the environment, most of it tends to concentrate in poorly ventilated areas. Inhaling it can cause dizziness and sensations of suffocation and

can develop lethal gas if in contact with naked flames or hot objects (see the refrigerant's safety data sheet in paragraph 4.4).





Pay attention to the fact that refrigerant fluids can be odourless

For any operation on the heat, pump system:

	<i>Wear the appropriate PPE (specifically gloves and goggles).</i>
	<i>Make sure that the workplace is well ventilated. Do not work in closed environments or ditches with little air circulation.</i>
	<i>Do not operate on the refrigerant in the vicinity of hot parts or naked flames.</i>
	<i>Do not release the refrigerant into the environment and pay special attention to accidental leakage from pipes and/or fittings even after having emptied the plant.</i>
	<i>Make sure there is a fire extinguisher near the unit</i>







4.2 PERSONAL PROTECTIVE EQUIPMENT

When operating and servicing the Vitocal 100-A units, the following personal protective equipment must be used:

	<i>Clothing: Maintenance technicians and operators must wear protective clothing that does not leave parts of the body uncovered, as during maintenance it is possible to come into contact with hot or sharp surfaces. Clothes that can become entangled or sucked in by airflows should be avoided. In case of slippery floors, they must also wear safety shoes with non-slip soles.</i>
	<i>Wear safety shoes with non-slip soles, especially in rooms with slippery floor.</i>
	<i>Gloves: During maintenance or cleaning operations, appropriate protective gloves must be used.</i>
	<i>Mask and goggles: Respiratory protection (mask) and eye protection (goggles) should be used during cleaning operations.</i>

4.3 SAFETY SIGNS

The unit features the following safety signs, which must be complied with:

	<i>Generic hazard</i>
	<i>Dangerous electric voltage</i>
	<i>Moving parts</i>
	<i>Surfaces which can cause injuries</i>
	<i>Boiling surfaces which can cause burns</i>
	<i>Fire hazard</i>

4.4 REFRIGERANT SAFETY DATA SHEET

Name:	R32.
HAZARDS IDENTIFICATION	
Main hazards:	Asphyxiation.
Specific hazards:	Quick evaporation could cause it to freeze.
FIRST AID MEASURES	
General information:	Do not administer to people who are unconscious.
Inhalation:	Immediately remove to fresh air. Use oxygen or artificial respiration as required. The use of adrenaline or similar drugs should be avoided.
Eye contact:	Carefully rinse with plenty of water for at least 15 minutes and get medical attention.
Skin contact:	Wash immediately with plenty of water for at least 15 minutes. Apply a sterile gauze. Immediately remove contaminated clothing.
FIRE FIGHTING MEASURES	
Extinguishing media:	Water spray, dry powder.
Specific hazards:	Breakage or explosion of vessel.
Specific methods:	Cool down the containers with a water spray from a safe position. Stop the product leakage if possible. Use water spray, if possible, to abate the fumes. Move the vessels away from the area of the fire if this can be done without posing any risks.
ACCIDENTAL RELEASE MEASURES	
Personal precautions:	Try to stop the leak. Evacuate personnel to safety areas. Eliminate the ignition sources. Ventilate appropriately. Use personal protective equipment.
Environmental precautions:	Try to stop the leak.
Cleaning methods:	Ventilate the area.
HANDLING AND STORAGE	
Handling: technical measures/precautions:	Allow efficient air exchange and/or suction the work environments.
advice for safe use:	Do not breathe in fumes or aerosol.
Storage:	Close carefully and store in a cool, dry and well-ventilated area. Keep in original containers. Incompatible products: explosive, flammable materials, organic peroxide
EXPOSURE CONTROLS/PERSONAL PROTECTION	
Control parameters:	OEL – data not available. DNEL: Derived no effect level (workers) Long-term – systemic effects, inhalation = 7035 mg/m ³ . PNEC: Predicted no-effect concentration water (fresh water) = 0.142 mg/l aquatic, intermittent releases = 1.42 mg/l sediment, fresh water = 0.534 mg/kg dry weight
Respiratory protection:	Not required.
Eye protection:	Safety goggles.
Hand protection:	Latex gloves.
Hygienic measures:	No smoking.

PHYSICAL AND CHEMICAL PROPERTIES

Colour:	Colourless.
Odour:	Ethereal. Hard to perceive at low concentrations.
Boiling point:	-51.7°C at atm. press.
Flash point:	648 °C.
Relative gas density (air =1)	1.8.
Relative liquid density (water =1)	1.1.
Solubility in water:	280000 mg/l.

STABILITY AND REACTIVITY

Stability:	Stable under normal conditions.
Materials to avoid:	Air, oxidizing agents, humidity.
Decomposition products hazardous:	Under normal storage and use conditions, hazardous decomposition products should not be generated.

TOXICOLOGICAL INFORMATION

Acute toxicity:	LD/LC50/inhalation/4 hours/on rat >1107000 mg/m ³ .
Local effects:	No known effect.
Long-term toxicity:	No known effect.

ENVIRONMENTAL INFORMATION

Global warming potential GWP (R744=1):	675
Ozone Depletion Potential ODP (R11=1):	0

Disposal considerations:	Refer to the supplier's gas retrieval program. Avoid direct release into the atmosphere.
--------------------------	--

4.5 SPECIFIC R32 GAS WARNINGS

The R32 refrigerant gas:

- is odourless;
- is flammable, but only if there are naked flames;
- it may cause an explosion, but only if a given concentration in air is reached.

It is good practice to adhere to the following indications:

- do not smoke near the unit;
- affix a no smoking sign near the unit;
- keep the premises where the unit is installed properly aerated;
- do not pierce or burn the unit;
- do not place the unit near ignition sources, such as naked flames, electric heaters etc.;
- every extraordinary maintenance or repair on the unit must be performed by skilled technicians or qualified personnel;
- a gas leak test must be performed after installation.

4.6 R32 GAS CHARGE

The procedures described below may only be performed by skilled technicians or qualified personnel:

- ensure the R32 is not contaminated by any other types of refrigerant;
- keep the gas cylinder in an upright position when charging;
- ground the refrigerant circuit
- apply the appropriate label on the unit after charging;
- do not charge more refrigerant gas than needed;
- when charging is completed, perform leak tests before the operating test;
- Once all the above operations have been completed, a second leak test should be performed.

4.7 R32 GAS DISPOSAL

The procedures described below may only be performed by skilled technicians or qualified personnel:

- Do not dispose of the gas in areas at risk of explosive mixtures forming with air the gas should be disposed of in an appropriate torch with backfiring stop device. Contact the supplier should you require operating instructions.

4.8 SAFETY RULES FOR R32 GAS TRANSPORT AND STORAGE

Before opening the unit's packaging, ensure there are no gas leaks in the environment with an appropriate gas detector. Ensure there are no fire ignition sources near the unit.

No smoking is allowed near the unit.

Transport and storage must be performed in accordance with the national regulations in force. Specifically, according to ADR provisions, the total maximum quantity by transport unit in terms of net mass for flammable gases is 333 kg.

5 INSTALLATION



CAUTION: QUALIFIED PERSONNEL ONLY must do all the operation described below. Before any operation on the unit, make sure that power is disconnected. Also, make sure that power cannot be accidentally switched back on until all the operations are over, by means of specific locks.

5.1 GENERAL

When installing or intervening on the chiller unit, it is necessary to strictly follow the rules listed in this manual, to observe all the indications on the unit and however to take all possible precautions. Failure to comply with the rules reported on this manual can create dangerous situations.













After receiving the unit, immediately check its integrity. The unit left the factory in perfect condition; any damage must be immediately reported to the carrier and recorded on the Delivery Note before signing it.

The company must be informed, within 8 days, of the extent of the damage. The Customer should prepare a written statement of any severe damage.



CAUTION: The units are designed for outdoor installation. The outside temperature must never exceed 46°C. Beyond this value, the unit is no longer covered by the current regulations in the field of safety of pressure equipment.

	CAUTION: The installation place must be without any fire risks. Therefore, all the necessary measures should be adopted in order to prevent the risk of fire at the installation place. The appliance must not be placed near naked flames and heat sources. The wall of the buildings near the unit must have an adequate fire resistance class, in order to contain any fire that may develop inside the rooms. However, it is recommended to place a fire extinguisher near the unit.
	CAUTION: The unit must be installed to allow free movement for repair and maintenance operations. The warranty does not cover costs for platforms or other lifting equipment needed for any interventions.
	QUALIFIED PERSONNEL ONLY must do all the maintenance operations and tests.
	Before any operation on the unit, make sure that power is disconnected.
	Do not use equipment to speed up the defrost process or for cleaning except for those recommended by the manufacturer
	The appliance must be placed in a room without ignition sources constantly running (for example naked flames, a running gas-fired appliance or a running electric heater)
	Do not perforate or burn
	CAUTION: There are some moving components inside the unit. Pay the utmost attention when operating in their vicinity, even if power is disconnected.
	The heads and delivery pipe of the compressor are normally quite hot.
	Be careful when working near the condensing coils. The aluminium fins are very sharp and can cause serious injuries.
	After the maintenance operations, close the panels by fixing them with screws.

5.1 Transport and storage limit temperature

Minimum storage temperature [°C]	-10°C
Maximum storage temperature [°C]	+50 °C

5.2 LIFTING AND HANDLING

The handling must be performed by qualified personnel, properly equipped with appropriate tools to the weight and the encumbrance of the unit, in compliance with safety regulations of accident preventing

Hints:^[EM1]

1. check the weight on unit technical label or on table of technical data;
2. check moving the unit there are no disconnected paths, ramps, steps, doors that could affect the movement and damage the unit;
3. make sure the unit stands while moving;
4. before moving the unit check the devices are suitable for lifting and preserving unit integrity;
5. perform lifting only by one of the listed procedures;
6. Before starting handling make sure, the unit is in stable equilibrium.

5.2.1 Lifting mode

Following lifting modes are allowed:



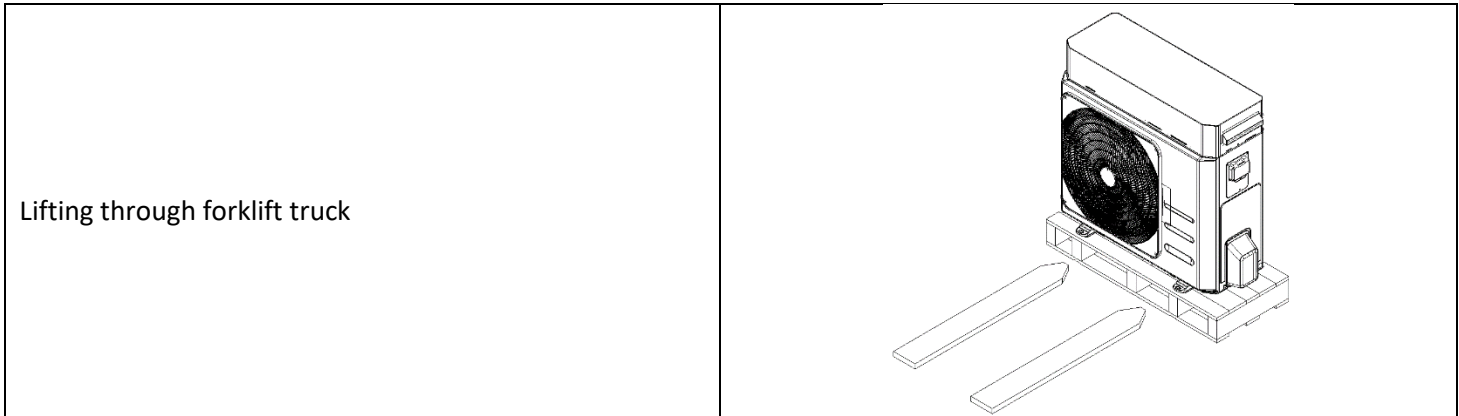

1. forklift truck
2. ropes/chains + sling bar

Make sure to tension the lifting ropes gradually and check their correct positioning.



5.3 POSITIONING AND MINIMUM TECHNICAL CLEARANCES

All models of the Vitocal 100-A range are designed and constructed for outdoor installations. It is advisable to create an adequately sized support base for the unit. The units transmit a small amount of vibrations to the ground: it is nonetheless advisable to apply vibration dampers between the base frame and support surface. It is very important to avoid recirculation between intake and delivery air, so as not to downgrade performance of the unit or even to interrupt its normal operation.

	<p><i>In case of hanging installation, it is necessary to make sure that the wall has been made with solid bricks, concrete or similar. The wall capacity needs to be enough to support at least four times the weight of the unit.</i></p>
	<p><i>The support plane must have enough capacity to support the unit weight, which can be checked both on the technical label on the unit and on this technical manual under “Technical data” chapter. The support plane must not be inclined to ensure the unit works properly and avoid a possible overturning. The support plane must not be smooth, to avoid water/ice deposit as potential sources of danger.</i></p>
	<p><i>Unit installation place must be free from foliage, dust, etc., which could clog or cover the coil. Installation in areas subject to water stagnation or fall, for example from gutters, should be avoided. Also, avoid areas subject to snow accumulation (such as corners of buildings with sloping roofs). In case of installation in areas subject to snowfall, place the unit on a base raised from the ground by 20-30 cm, to prevent the formation of snow accumulations around the machine.</i></p>
	<p><i>At least 5 m from the appliance there must be no shafts or manholes where gases might build up and generate an explosive atmosphere.</i></p>

It is very important to avoid recirculation between intake and delivery air, so as not to downgrade performance of the unit or even to interrupt its normal operation.

This is why the Minimum clearances shown below must be strictly guaranteed.

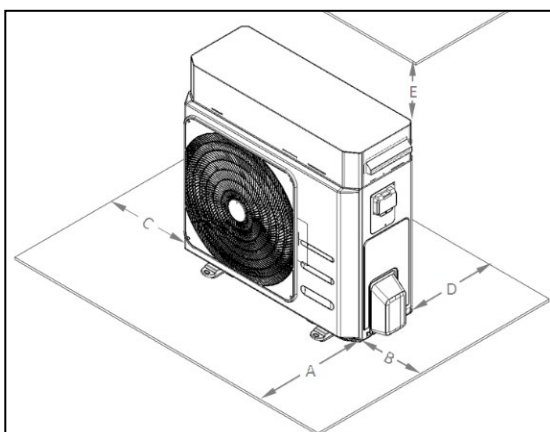

MODEL	A [mm]	B [mm]	C [mm]	D [mm]	E [mm]
AWO-M-AC 101.A06	1500	500	400	400	500
AWO-M-AC 101.A08	1500	500	400	400	500
AWO-M-AC 101.A10	1500	500	400	400	500
AWO-M-AC 101.A12	1500	500	400	400	500
AWO-M-AC 101.A14 AWO-AC 101.A14	1500	500	400	400	500
AWO-M-AC 101.A16 AWO-AC 101.A16 AWO-AC 101.A18	1500	500	400	400	500

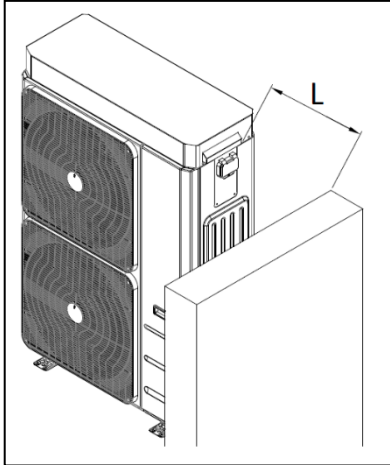

MODEL	L [mm]
AWO-M-AC 101.A06	500
AWO-M-AC 101.A08	500
AWO-M-AC 101.A10	500
AWO-M-AC 101.A12	500
AWO-M-AC 101.A14	500
AWO-M-AC 101.A16	500
AWO-AC 101.A16	500
AWO-AC 101.A18	500

	Do not obstruct or cover the vents on the top cover.
	For strong wind installation place refer to the classification of the area according to the Beaufort table. If the value is ≥ 7 (strong wind, average wind speed = 13, 9-17, 1 m/s) it is strictly necessary to keep the fan always powered, thus preventing involuntary rotation of the same.

In the event of side-by-side units, the minimum Lmin distance between them is 1 m.

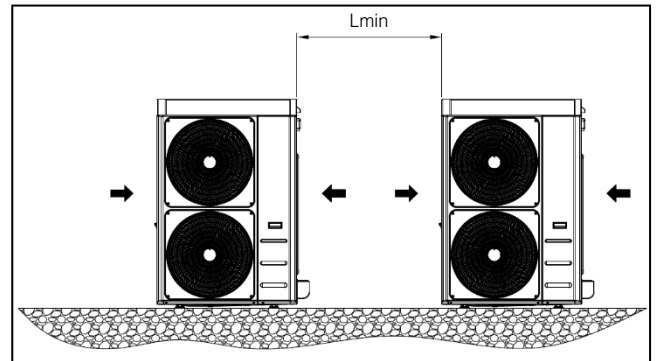

Covering with canopies or placing near plants or walls should be avoided to prevent air recirculation.

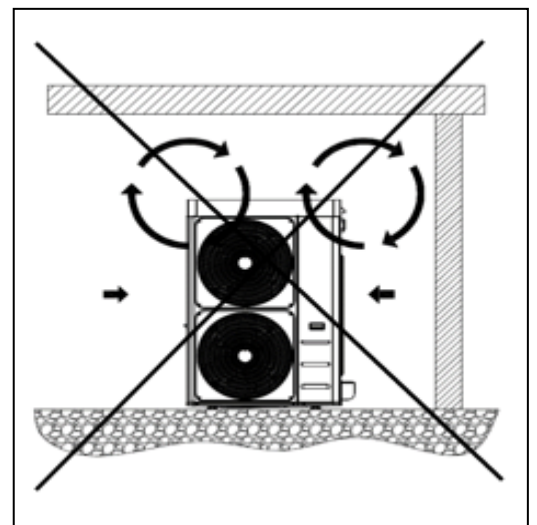

In the event of winds stronger than 2.2 m/s the use of wind barriers is recommended.

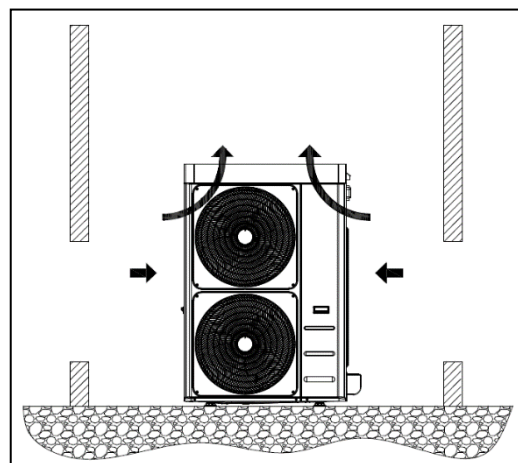

5.4 DIMENSIONS

5.4.1 Model Vitocal 100-A 06 / 08

IN/OUT: 1" M G

E: power supply input

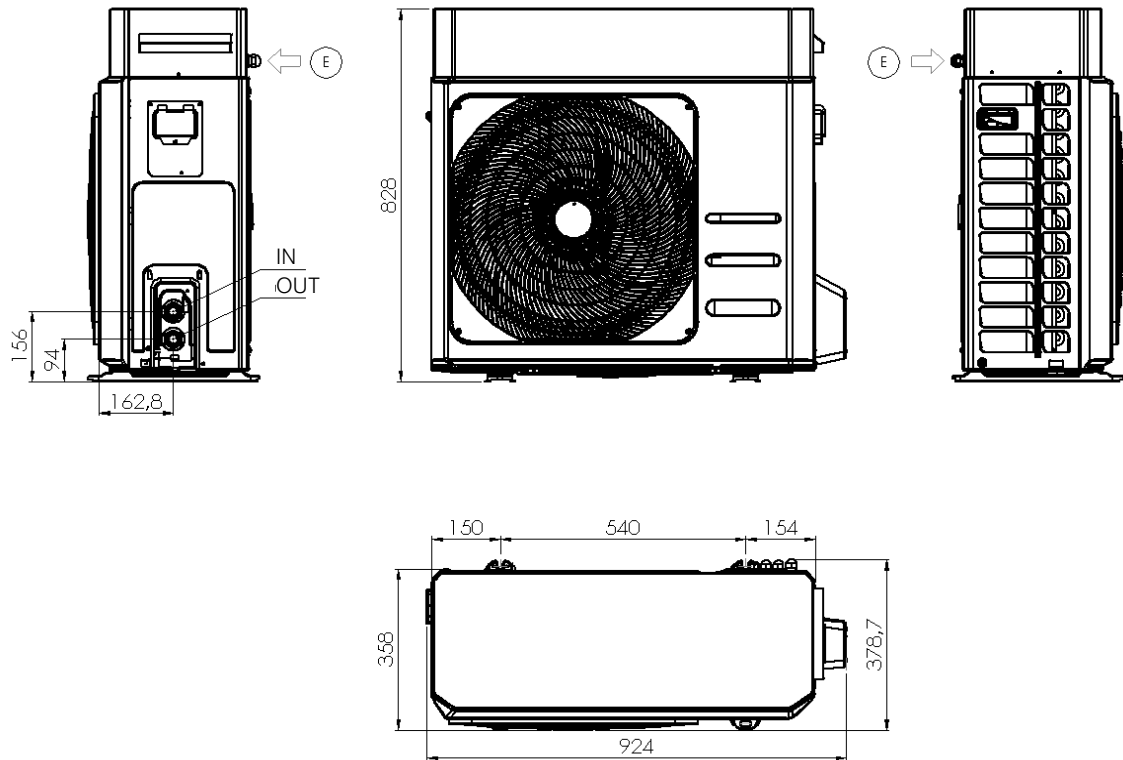

5.4.2 Model Vitocal 100-A 10 / 12

IN/OUT: 1" M G

E: power supply input

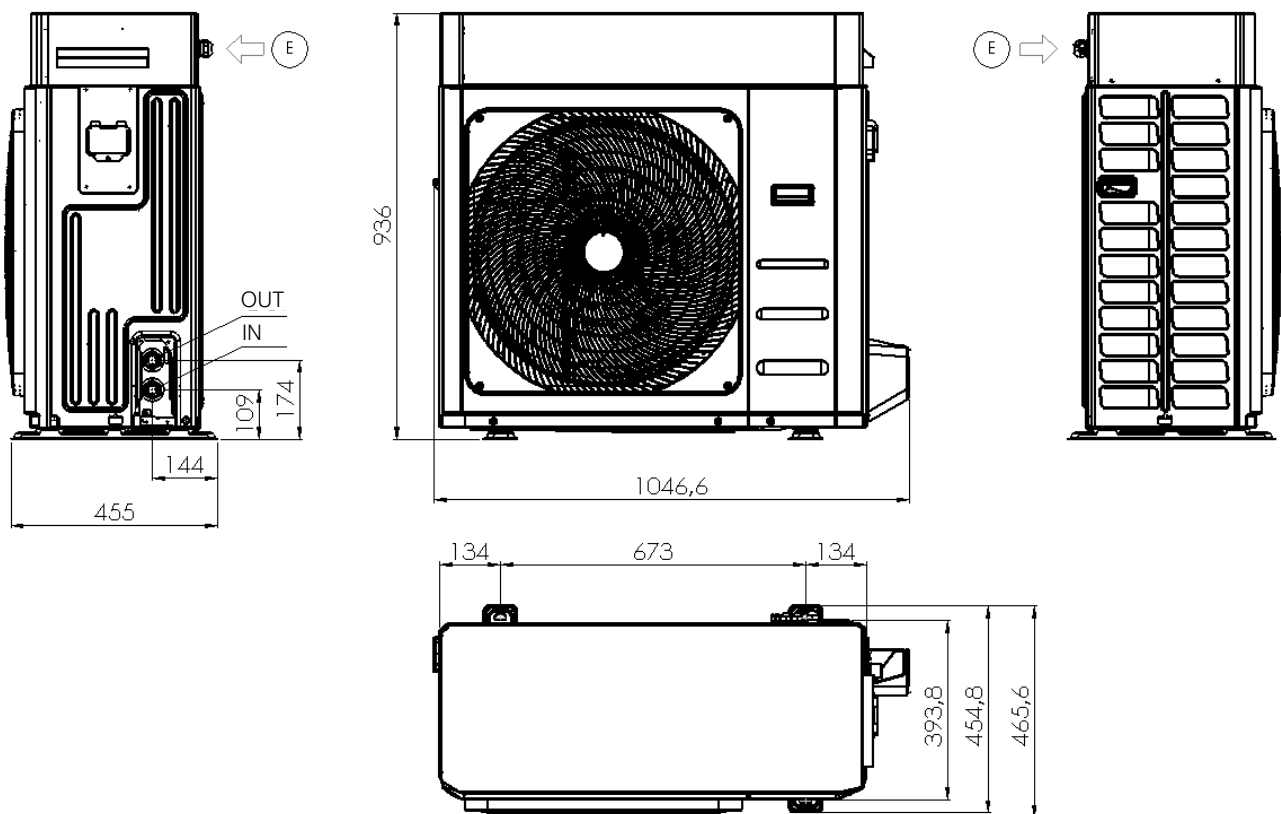

5.4.3 Model Vitocal 100-A 14 / 16 / 18

IN/OUT: 1" M G

E: power supply input

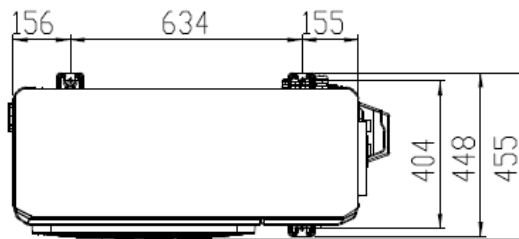
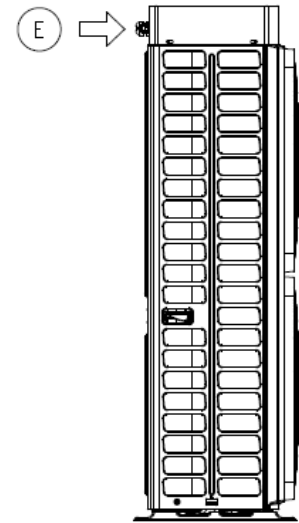
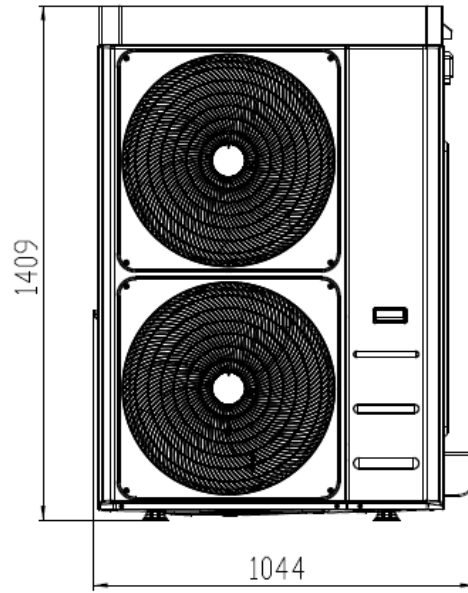
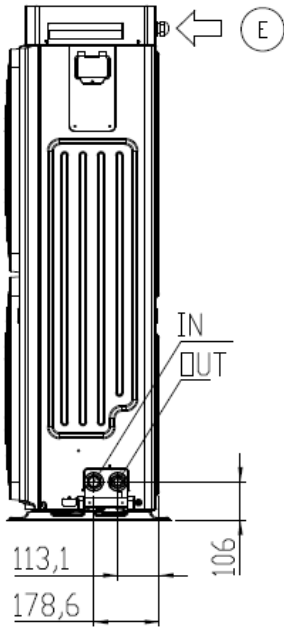

5.5 ACCESSING THE INNER PARTS

5.5.1 Mod. Vitocal 100-A 06 / 08

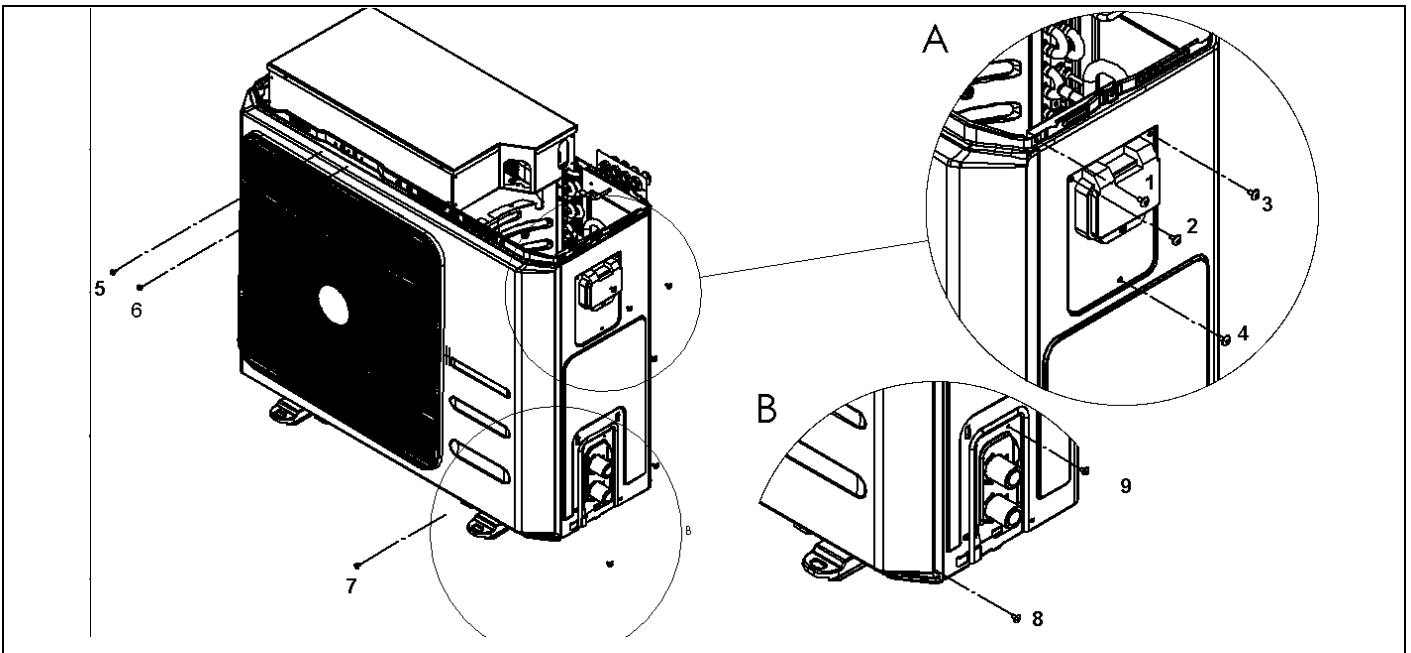

- 1) Remove the cover
- 2) Undo the screws (number 2; 3; 4) of the sheet metal cover of the user interface and the screw (number 1) of the side panel to separate the front sheet metal from the side panel (Detail A).
- 3) Undo in sequence the screws (number 5; 6; 7) in order to move the front panel slightly forward and to be able to reach the screw (number 8) visible in detail B.
- 4) Undo the screws (number 8; 9 visible in detail B) and those on the coil side of the unit. To remove the side panel, pull it upwards (to free the tab at the base) and remove it.

5.5.2 Mod. Vitocal 100-A 10 / 12

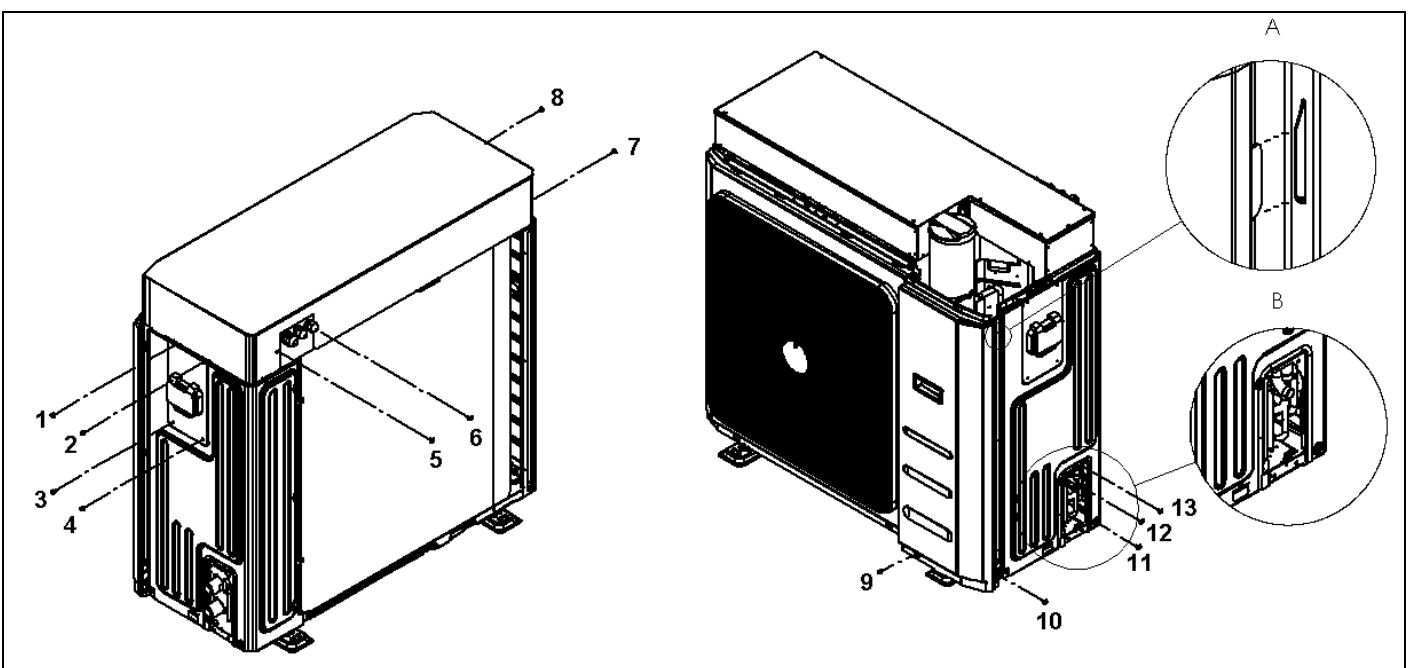

- 1) Remove the cover by undoing the screws (number 1; 2; 3; 4; 5; 6; 7; 8).
- 2) Undo the screws (number 9; 10) of the front sheet and then push the panel downwards to remove the tabs (Detail A); pull the panel forward to remove it.
- 3) Undo the screws (number 11; 12; 13) and those on the coil side of the unit. To remove the side panel, pull it upwards (to free the tab at the base) and remove it.

5.5.3 Mod. Vitocal 100-A 14 / 16 / 18

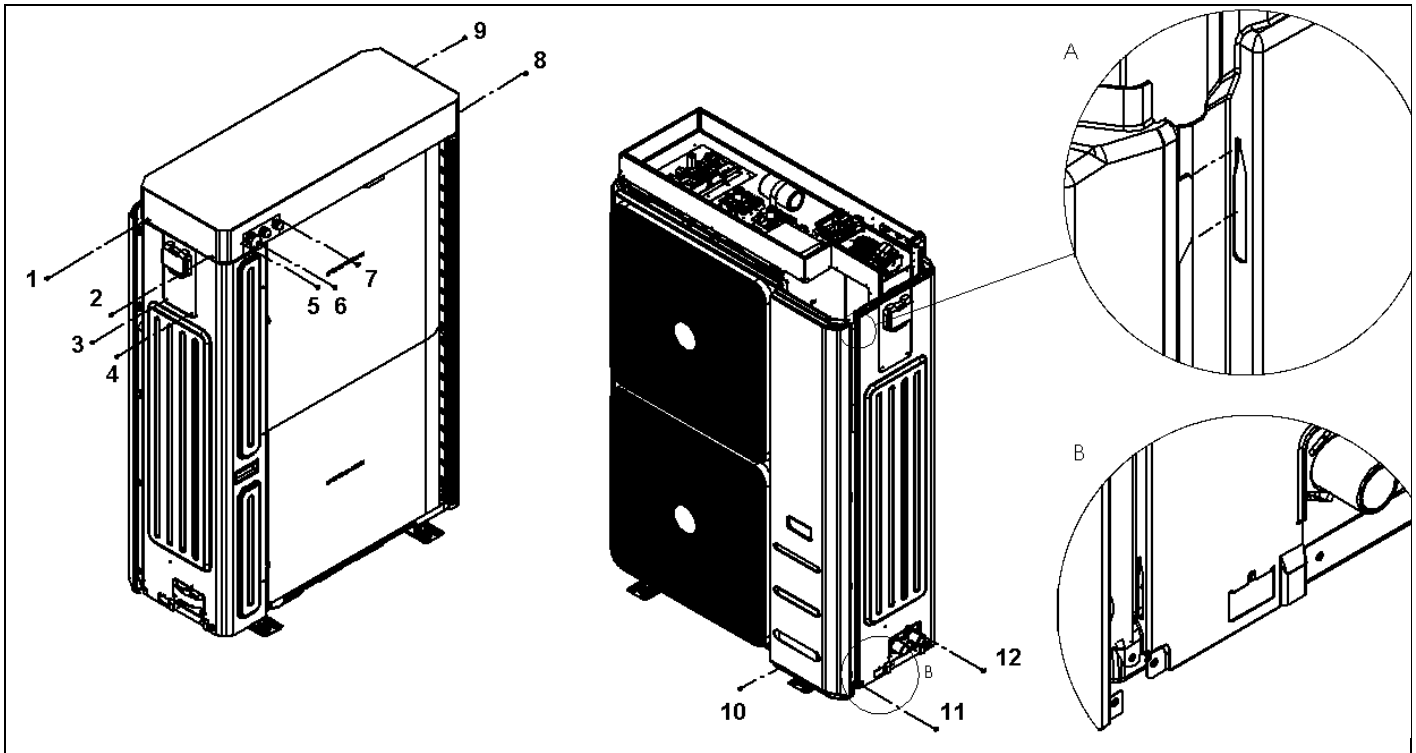

- 1) Remove the cover by undoing the screws (number 1; 2; 3; 4; 5; 6; 7; 8; 9).
- 2) Undo the screws (number 10; 11) of the front sheet and then push the panel downwards to remove the tabs (Detail A); pull the panel forward to remove it.
- 3) Undo the screw (number 12) and those on the coil side of the unit. To remove the side panel, pull it upwards (to free the tab at the base) and remove it.

5.6 PLUMBING CONNECTIONS

The plumbing connections must be made in accordance with national and/or local regulations; pipes can be made of steel, galvanised steel or PVC. Pipes must be accurately sized according to the nominal water flow rate of the unit and the pressure drops of the water circuit. All pipes must be insulated with closed-cell material of adequate thickness. The chiller must be connected to the pipes using new flexible joints, not reused ones. The water circuit should include the following components:

- Well thermometers to monitor the circuit's temperature.
- Manual gate valves to isolate the chiller from the water circuit.
- Metal Y filter and dirt separator (installed on the return pipe) with metal mesh no larger than 1 mm.
- Loading group and exhaust valve where necessary.



CAUTION: when sizing the pipes, make sure not to exceed the maximum pressure drop on plant side reported in the technical data table in Paragraph 11 (see useful head).

CAUTION: connect the pipes to their fittings always using the key-to-key method.

ATTENTION: create a suitable drain for safety valve.

ATTENTION: the installer has to verify if the expansion tank fits with the real capacity of the installation.

CAUTION: The return pipe from the system must be installed near the label “WATER INLET” otherwise, the evaporator could freeze.

CAUTION: It is mandatory to install a metal filter (with mesh no larger than 1 mm) and a dirt separator on the return pipe from the system labelled “WATER INLET”. If the flow switch is manipulated or altered, or if the metal filter and dirt separator are missing, the warranty will terminate immediately. The filter and dirt separator must be kept clean. Therefore, after installing the unit, you must make sure that they are still clean and check them regularly.

All of the units leave the company supplied with flow switch (installed in factory). If the flow switch is altered or removed or if the water filter and dirt separator are missing from the unit, the guarantee will be void. Refer to the wiring diagram attached to the unit to connect the flow switch. Never jumper connections of the flow switch in the terminal block.

The heating system and the safety valves must comply with the requirements of standard EN 12828.

5.6.1 Features of the circuit water

To guarantee correct operation of the unit, the water must be appropriately filtered (see the instructions at the start of this paragraph) and there must be only a minimum amount of dissolved substances. The maximum allowed values are shown below

MAXIMUM CHEMICAL-PHYSICAL PROPERTIES ALLOWED FOR THE CIRCUIT WATER	
PH	7.5 - 9
Electrical conductivity	100 - 500 μ S/cm
Total hardness	4.5 – 8.5 dH
Temperature	< 65°C
Oxygen content	< 0.1 ppm
Max glycol quantity	40 %
Phosphates (PO4)	< 2ppm
Manganese (Mn)	< 0.05 ppm
Iron (Fe)	< 0.3 ppm
Alkalinity (HCO3)	70 – 300 ppm
Chloride ions (Cl-)	< 50 ppm
Sulphate ions (SO4)	< 50 ppm
Sulphide ions (S)	None
Ammonium ions (NH4)	None
Silica (SiO2)	< 30 ppm

5.6.2 Typical plumbing diagram

A recommended connection diagram is shown below.

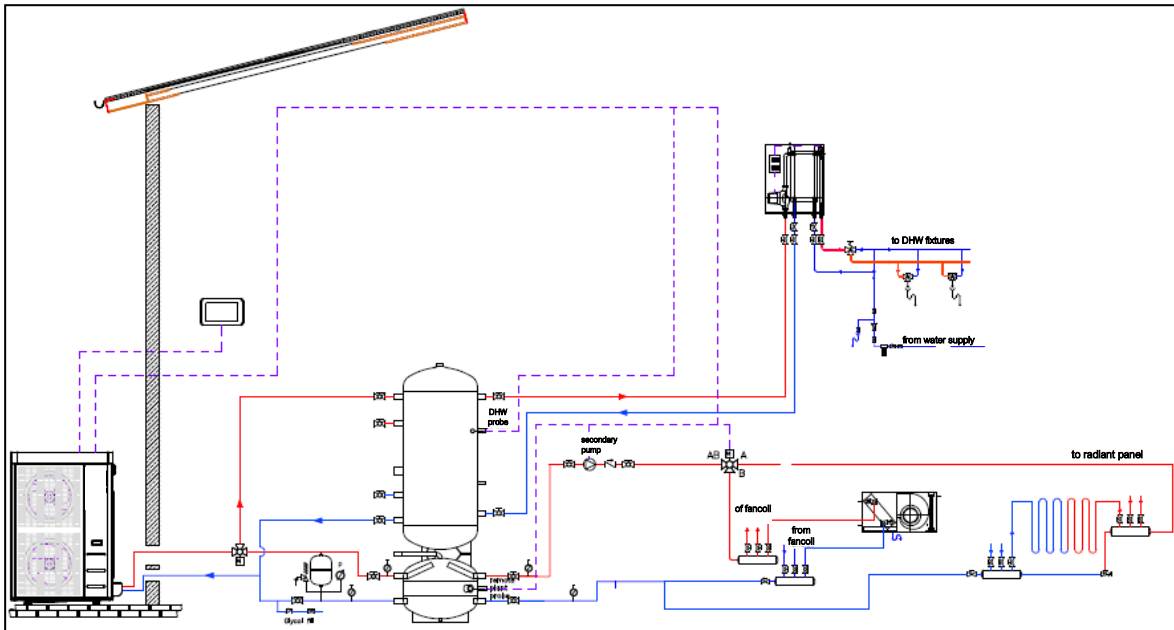

5.6.3 Handbook

If you need more information about the possible configurations, there is a handbook, which is a technical notebook, including a series of system diagrams that have been highlighted regarding the installation configuration of our high efficiency heat pumps. The Handbook is also intended to show the symbiosis potential with some of our products found in the catalogue. Consult the technical notebook at our headquarters.

5.6.4 Condensation discharge system

All Vitocal 100-A units are built in such a way that the base of the unit acts as a condensate drip tray. A plastic fitting is standard supplied to be connected below the base in the specific slot in order to connect a pipe, which channels the condensate.

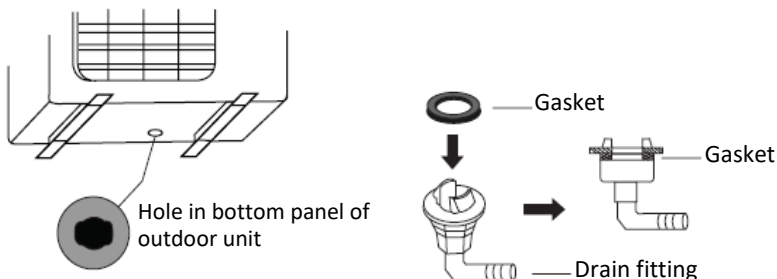

Each unit is therefore fitted with a hole on the base of the hydronic kit (on the coil side) to drain condensation which could drip from the pipes of the plumbing system. Since these pipes are well insulated, a minimum amount of condensation is produced anyway and therefore it is not mandatory to connect a drainpipe to this fitting.

ESPECIALLY IN VERY COLD CLIMATE REGIONS, IT IS RECOMMENDED TO INSTALL ELEVATION SUPPORTS IN ORDER TO ALLOW ICE FORMATION UNDER THE UNIT WITHOUT DAMAGING IT BY FREEZING.

5.6.5 Filling the system

	CAUTION: supervise all filling/top-up operations.
	CAUTION: before filling/topping up the system, disconnect power to the units.
	CAUTION: the system must always be filled/topped up in controlled pressure conditions (max 1 bar). Make sure that a pressure reducer and safety valve have been installed on the filling/top-up line.
	CAUTION: the water on the filling/top-up line must be appropriately pre-filtered from any impurities and suspended particles. Make sure that a removable cartridge filter and dirt separator are installed on the line.
	CAUTION: regularly check and vent the air built up in the system.
CAUTION: install an automatic air-venting valve at the highest point of the system.	

5.6.6 Discharge of the plant

If the unit needs to be drained completely, first close the manual inlet and outlet gate valves (not included in supply) and then detach the pipes on the outside of the water inlet and outlet to drain liquid from the unit (to make this operation easier, it is recommended to install two drain valves between the unit and manual gate valves on the outside of the water inlet and outlet).

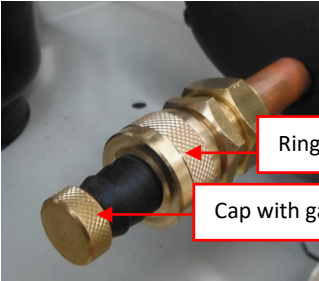
	<p>When it is required to top up the circuit or to adapt the glycol level, please use the service valve. Unscrew and remove the cap from the service valve and connect a 14 or 12 mm pipe (inside diameter - check the valve model installed on your unit), connected to the water mains, to the hose connector and then drain the circuit by unscrewing the specific ring nut. After the end of the operation, retighten the ring nut and screw the cap back on. In any case, it is recommended to use an external valve to fill the system, which can be set up by the installer.</p>
--	---

5.6.7 Service sleeves

Two service sleeves with cap (1/4" G) are installed in the unit's water circuit, downstream and upstream of the circulator (ref. SM unit functional diagram paragraph 5.6.2); when disassembling/fitting on the cap use two spanners as pictured to prevent damaging the pipes.

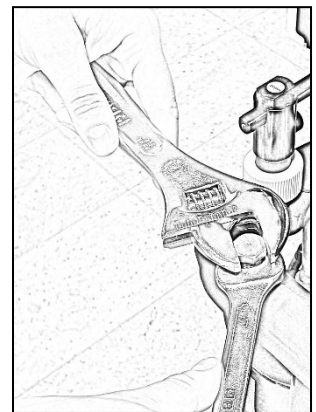

5.6.8 Air venting valve

The unit is fitted with an air-venting valve to automatically remove air that has built up in the circuit, preventing undesirable effects such as premature corrosion and wear, lower performance and low exchange output.

The device also features a safety function because, in the event of exchanger breakdown, it allows the refrigerant gas to escape outside, preventing it from being conveyed to the internal terminals. The valve can be kept in a closed position by closing the plug on the drain; by loosening the plug, the valve remains in open position and air is vented automatically.

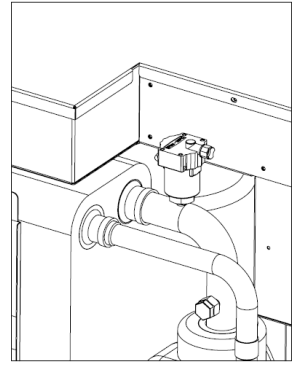

In the event of observing a water leak, it is mandatory to replace the component, by loosening it with a wrench, as pictured below.



5.6.8.1 FUNCTIONAL DIAGRAMS

5.6.9 Vitocal 100-A 06 / 08

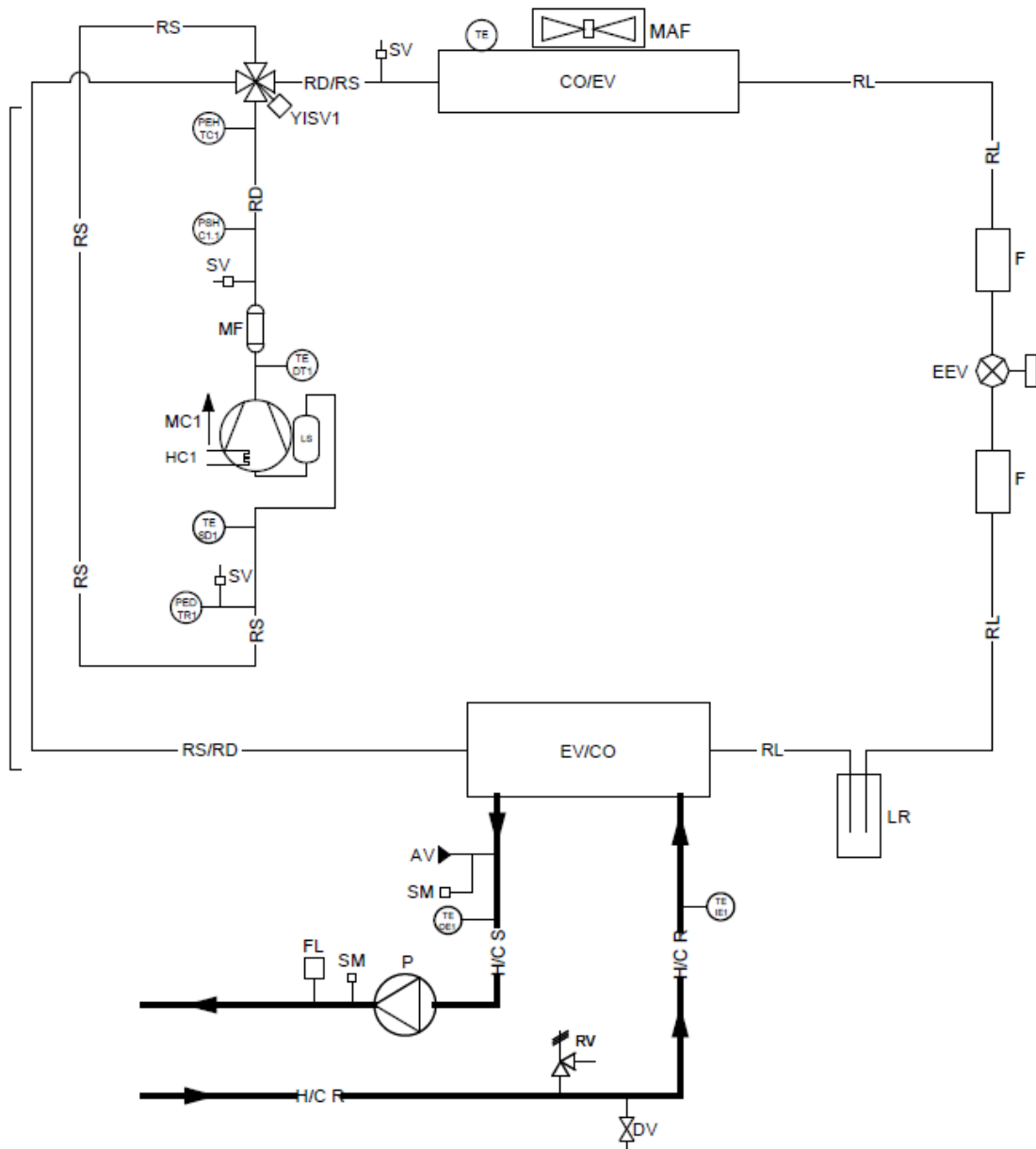

KEY					
CODE	NUM.	DESCRIPTION	CODE	NUM.	DESCRIPTION
MC	1	COMPRESSOR	H/CS		UTILITY WATER OUTLET
CO/EV		CONDENSER (IN CHILLER MODE)	H/CR		UTILITY WATER INLET
EV/CO		EVAPORATOR (IN CHILLER MODE)	PEHTC	1	HIGH PRESSURE TRANSDUCER
EEV		ELECTRONIC EXPANSION VALVE	PEDTR	1	LOW PRESSURE TRANSDUCER
YISV	1	4-WAY CYCLE REVERSING VALVE	TE		OUTDOOR AIR TEMPERATURE PROBE
LR		LIQUID RECEIVER	TE SD	1	INTAKE LINE TEMPERATURE PROBE
F		FILTER	TE DT	1	COMPRESSOR DISCHARGE TEMPERATURE PROBE
SV		FILLING CONNECTION	PSHC	1.1	AUTOMATIC RESET HIGH-PRESSURE SWITCH
HC	1	CRANKCASE HEATER	TE IE	1	UTILITY INLET TEMPERATURE PROBE
MAF		AXIAL FAN	TEOE	1	UTILITY OUTLET TEMPERATURE PROBE
MF		MUFFLER	DV		DRAIN VALVE
LS		LIQUID SEPARATOR	RV		SAFETY VALVE
RS		INTAKE LINE	FL		FLOW SWITCH
RD		DELIVERY LINE	P		PUMP
RL		LIQUID LINE	AV		AUTOMATIC AIR VENTING VALVE
RD/RS		DELIVERY/INTAKE LINE	SM		SERVICE SLEEVE
RS/RD		INTAKE/DELIVERY LINE			

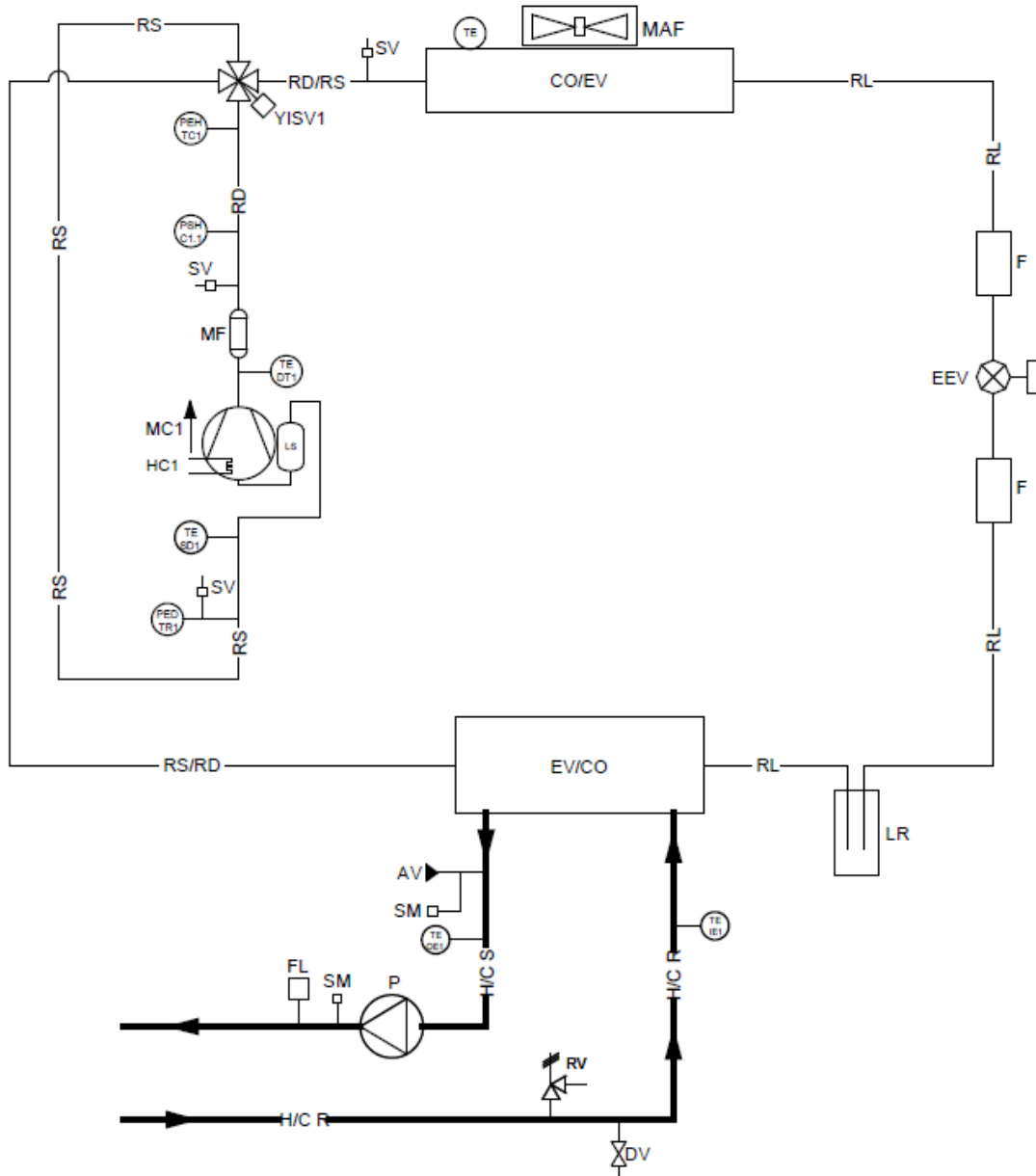

KEY					
CODE	NUM.	DESCRIPTION	CODE	NUM.	DESCRIPTION
MC	1	COMPRESSOR	H/CS		UTILITY WATER OUTLET
CO/EV		CONDENSER (IN CHILLER MODE)	H/CR		UTILITY WATER INLET
EV/CO		EVAPORATOR (IN CHILLER MODE)	PEHTC	1	HIGH PRESSURE TRANSDUCER
EEV		ELECTRONIC EXPANSION VALVE	PEDTR	1	LOW PRESSURE TRANSDUCER
YISV	1	4-WAY CYCLE REVERSING VALVE	TE		OUTDOOR AIR TEMPERATURE PROBE
LR		LIQUID RECEIVER	TE SD	1	INTAKE LINE TEMPERATURE PROBE
F		FILTER	TE DT	1	COMPRESSOR DISCHARGE TEMPERATURE PROBE
SV		FILLING CONNECTION	PSHC	1.1	AUTOMATIC RESET HIGH-PRESSURE SWITCH
HC	1	CRANKCASE HEATER	TE IE	1	UTILITY INLET TEMPERATURE PROBE
MAF		AXIAL FAN	TE OE	1	UTILITY OUTLET TEMPERATURE PROBE
MF		MUFFLER	DV		DRAIN VALVE
LS		LIQUID SEPARATOR	RV		SAFETY VALVE
RS		INTAKE LINE	FL		FLOW SWITCH
RD		DELIVERY LINE	P		PUMP
RL		LIQUID LINE	AV		AUTOMATIC AIR VENTING VALVE
RD/RS		DELIVERY/INTAKE LINE	SM		SERVICE SLEEVE
RS/RD		INTAKE/DELIVERY LINE			



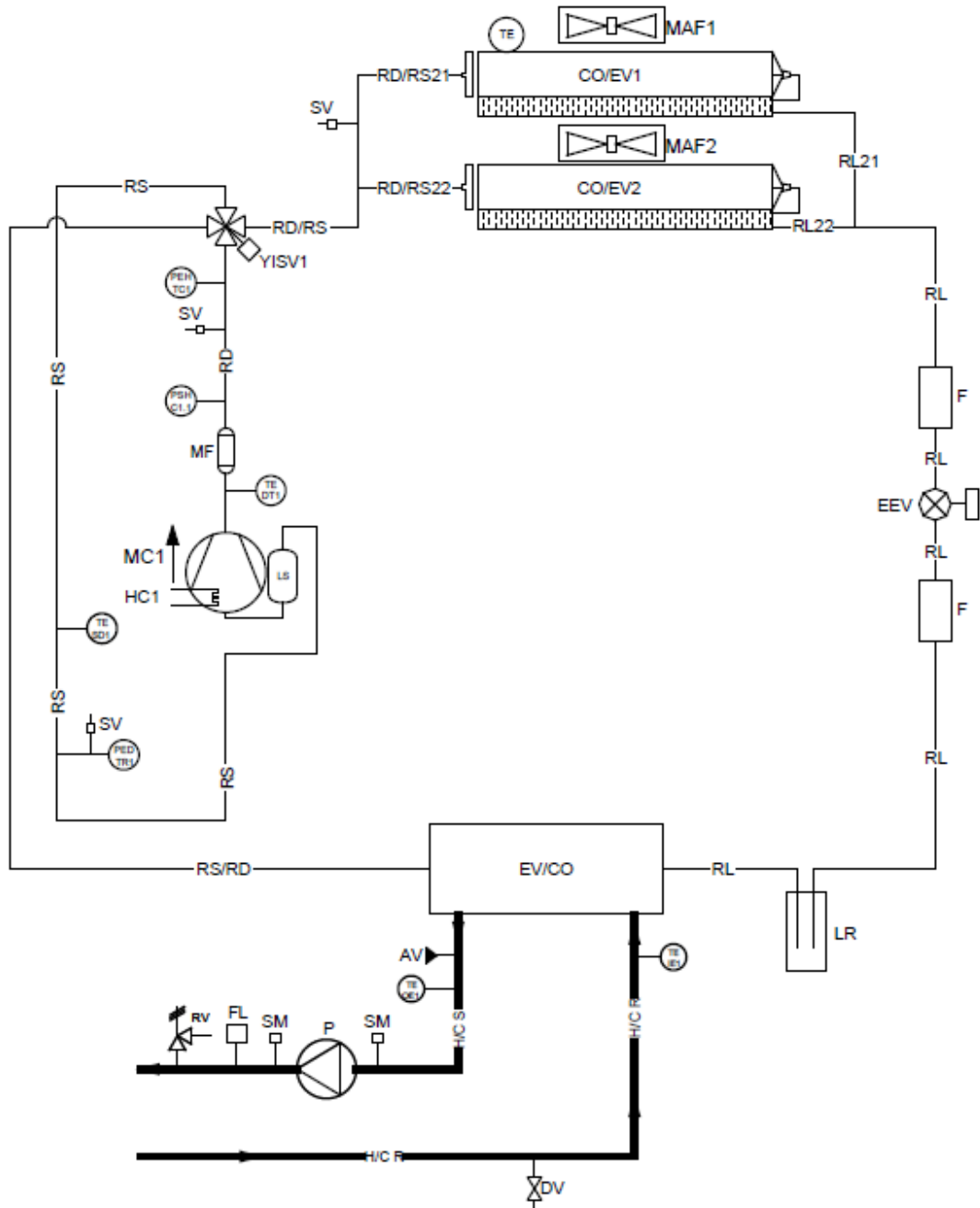





5.6.10 Vitocal 100-A 14 / 16 / 18



KEY					
CODE	NUM.	DESCRIPTION	CODE	NUM.	DESCRIPTION
MC	1	COMPRESSOR	H/CS		UTILITY WATER OUTLET
CO/EV	1.2	CONDENSER (IN CHILLER MODE)	H/CR		UTILITY WATER INLET
EV/CO		EVAPORATOR (IN CHILLER MODE)	PEHTC	1	HIGH PRESSURE TRANSDUCER
EEV		ELECTRONIC EXPANSION VALVE	PEDTR	1	LOW PRESSURE TRANSDUCER
YISV	1	4-WAY CYCLE REVERSING VALVE	TE		OUTDOOR AIR TEMPERATURE PROBE
LR		LIQUID RECEIVER	TE SD	1	INTAKE LINE TEMPERATURE PROBE
F		FILTER	TE DT	1	COMPRESSOR DISCHARGE TEMPERATURE PROBE
SV		FILLING CONNECTION	PSHC	1.1	AUTOMATIC RESET HIGH-PRESSURE SWITCH
HC	1	CRANKCASE HEATER	TE IE	1	UTILITY INLET TEMPERATURE PROBE
MAF	1.2	AXIAL FAN	TEOE	1	UTILITY OUTLET TEMPERATURE PROBE
MF		MUFFLER	DV		DRAIN VALVE
LS		LIQUID SEPARATOR	RV		SAFETY VALVE
RS		INTAKE LINE	FL		FLOW SWITCH
RD		DELIVERY LINE	P		PUMP
RL		LIQUID LINE	AV		AUTOMATIC AIR VENTING VALVE
RD/RS		DELIVERY/INTAKE LINE	SM		SERVICE SLEEVE
RS/RD		INTAKE/DELIVERY LINE			

5.7 ELECTRICAL CONNECTIONS

Check, that the power supply matches the unit's electric nominal data (voltage, phases, and frequency) displayed on the rating plate on the unit's side panel. The electric power connections must be made in accordance to the wiring diagram enclosed with the unit and in conformity with national and international standards (providing general circuit breaker, residual current devices for each line, proper earthing of the plant, etc.).

	ATTENTION: Before any operation on the unit, make sure that power is disconnected.
	CAUTION: The electric panel is positioned below the cover. Respect the minimum clearances shown in chapter 5.3 to perform wiring.
	CAUTION: The installer is responsible for the disconnection system (e.g. general circuit breaker) upstream of the electrical connections of the unit.
	CAUTION: The supply voltage's fluctuations cannot exceed $\pm 10\%$ of the nominal value. If this tolerance should not be respected, please contact the energy provider. The power supply to must respect the above-mentioned limits, contrary la guarantee will immediately decays.
	CAUTION: If the supply cable is damaged, it must be replaced by qualified personnel, in order to prevent any risk
	ATTENTION: Any devices placed nearby can cause / suffer electromagnetic disturbances to / from the unit. Be aware of this risk at the installation site. It is recommended to electrically power the unit with an adequate line and protections and use an independent cable duct.
	CAUTION: The flow switch (element B in the previous hydraulic diagram and installed in the factory) must ALWAYS be connected following the indications given in the electrical diagram. Never bridge the flow switch connections in the terminal block. The warranty will no longer be considered valid if the flow switch connections have been altered or incorrectly connected.
	CAUTION: The remote control panel is connected to the chiller by 4 cables with a cross-section of 1.5 mm ² . The power cables must be separate from the remote control cables. Maximum distance 50 metres.
	CAUTION: The remote control panel cannot be installed in an area with strong vibrations, corrosive gases, excessive filth or high humidity. Leave the area near the chiller clear.

5.7.1 Access to the electric panel

The following is the procedure to remove the cover. The images show sizes 14/16 but they also apply to the other sizes.

1. Undo the screws, which secure the cover. Two on each side of the machine and two, which secure the cover to the support of the cable glands. (There is just one fixing screw on the side of the smaller-sized controllers).
2. Remove the screws that fasten the cover of the electric panel and wire to the terminal block.
3. Insert the cable in the cable glands on the side of the machine to bring them outside of the unit.
4. Close the electric panel and the cover of the machine by reapplying the screws.

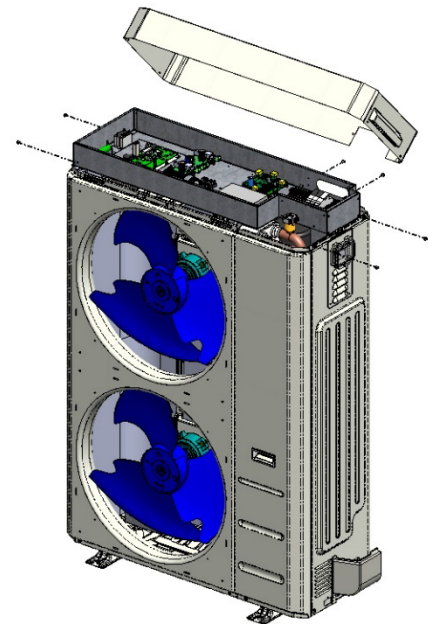

The above-mentioned operations must be carried out with the machine off and power disconnected (by means of the specific disconnecter applied by the installer).

Operations carried out by qualified personnel.

Remove the cover without removing the support plate of the cable glands.

When the work is finished, close all of the removed covers applying the screws and gaskets (if included).



5.7.2 Power supply terminal block



Only QUALIFIED PERSONELL, in accordance with current regulations, can make the electrical wiring.



Make sure to carry out a correct grounding, an incorrect grounding can lead to electric shock. The builder is not responsible for non può essere considerato responsabile for any damage caused by failure or ineffective grounding.

Power cables, electric protections and line wired need to be dimensioned in accordance with wiring diagram and electric data in the table of technical features (See paragraph 11).

Use a dedicated power supply line, do not power the unit through a line to which other consumers are connected. Secure the power cables firmly and make sure they do not come into contact with sharp corners. Use double-insulated cables with copper wires

The earth connection must be made first during connection, vice versa it must be removed last when disconnecting the unit. In case of a possible loosening of the power cable, it must be guaranteed that the tensioning of the active conductors takes place before that of the earth wire.

A main switch or disconnecting device with adequate breaking power must be installed on the power supply line, which has contact separation at all poles. The earth leakage circuit breaker must be compatible with inverter devices, it is recommended to install a type B earth leakage circuit breaker, the installation of a different type breaker may result in untimely trips.

The following table shows the recommended cable cross sections for a maximum length of 30 m. In any case, depending on the type of installation, the physical location and the length of the cables (whether less or more than 30m), it will be the responsibility of the designer of the electrical system to make an appropriate choice.

Power supply	Model	Recommended cable section (max length 30 m)	Recommended tightening torque
230V / 1ph	06 / 08	3 x 4 mm ²	L/N: 3,4 Nm – PE: 1 Nm
230V / 1ph	10 / 12	3 x 4 mm ²	L/N: 3,4 Nm – PE: 1 Nm
230V / 1ph	14 / 16	3 x 6 mm ²	L/N: 3,4 Nm – PE: 1 Nm
400V / 3ph	10T / 12T	5 x 2,5 mm ²	L1/L2/L3: 3,4 Nm – N/PE: 1 Nm
400V / 3ph	14T / 16T	5 x 2,5 mm ²	L1/L2/L3: 3,4 Nm – N/PE: 1 Nm
400V / 3ph	18T	5 x 4 mm ²	L1/L2/L3: 3,4 Nm – N/PE: 1 Nm

The units comply with the electromagnetic compatibility specifications, however the designer of the electrical system must fulfil appropriate assessments to ensure the absence of interference.

5.7.3 User terminal block

The connection terminal block is located under the machine cover. For access, see the instructions in paragraph 5.8.1. The terminal block must be connected respecting the notes below.

The connections shown below are standard. Other connections are given in the MCO manual of the on-machine control of the Vitocal 100-A (see "USER AND INSTALLER CONFIGURATION TABLES"), according to the configurations adopted.

	ATTENTION: It is important to keep the high voltage cables separate from the very low voltage ones.
---	--

TERMINAL	CONNECTION	TYPE
X-1	Connect ground wire	Input for power supply 1-Ph/N/PE, 230V, 50Hz (only for size 06/08/10/12/14/16)
N	Connect the neutral cable from the mains	
L	Connect the phase cable from the mains	
PE	Connect the earth cable	Input for power supply 3-Ph/N/PE, 400 Vac, 50Hz. (only size 14T and 16T)
N	Connect the neutral cable from the mains	
L1	Connect the phase cable L1 from the mains	
L2	Connect the phase cable L2 from the mains	
L3	Connect the phase cable L3 from the mains	Modbus Communication
X-5.2	Connection of Modbus RTU signal + for remote keyboard	
X-5.1	Connection of Modbus RTU signal – for remote keyboard	
X-4.1	Connection of Modbus RTU earth reference for remote keyboard (GND)	Power supply Output 12Vac, 50Hz
X-12.1	Remote keyboard power supply (12V, 50Hz, 500mA)	
X-12.2	Remote keyboard power supply (12V, 50Hz, 500mA)	Analogic or digital input
X-17.1/X-17.2	ACS Probe (SAN1)	
X-19.1/19.2	Plant remote implant (IMP1)	Analogic input
X-20.1/X-20.2	Double set point (Q4)	Analog input
X-22.2	Signal input 0-10V (+) to modify set point	Analog input (ST10)

X-22.1	Signal input 0-10V (-) to modify set point	
X-6.1/X-6.2	Installation resistance (Rimp)	Output in single-phase voltage 230Vac, 50Hz, 5A resistive, 1A inductive. Can be used in versions without KA
X-9.1/X-9.2	Heat exchanger electrical resistance (R2)	Output in single-phase voltage 230Vac, 50Hz, 5A resistive, 1A inductive. Can be used in versions without KA
X-10.1/X-10.2	Basement resistance (R3)	Output in single-phase voltage 230Vac, 50Hz, 5A resistive, 1A inductive.
X-11.1/X-11.2	Domestic hot water valve output (VS1)	Changeover contact, single-phase voltage 230Vac, 50Hz, 5A resistive, 1A inductive.
X-14.1/X-14.2	Double set point output valve (VDS1)	Changeover contact, single-phase voltage 230Vac, 50Hz, 5A resistive, 1A inductive.
X-16.1/X16.2	Summer/winter remote mode input change (to enable see related paragraph in MCO manual)	Voltage free digital input
X-15.1/X15.2	Input on/off remote (close=machine on / open =machine off)	Voltage free digital input

06/08 kW

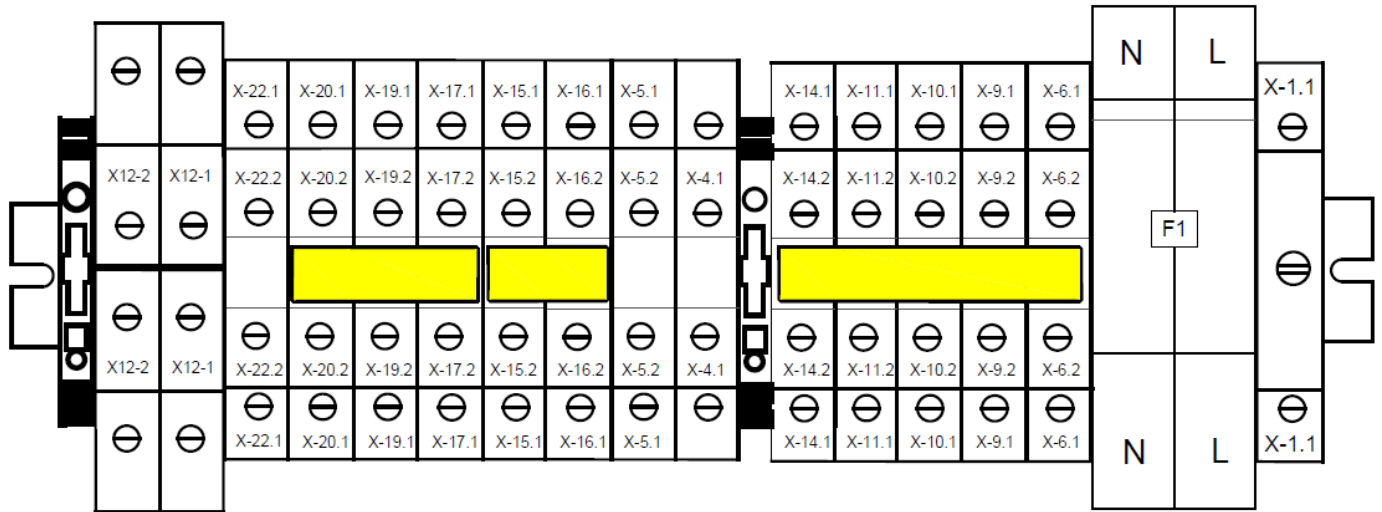

10/12 kW

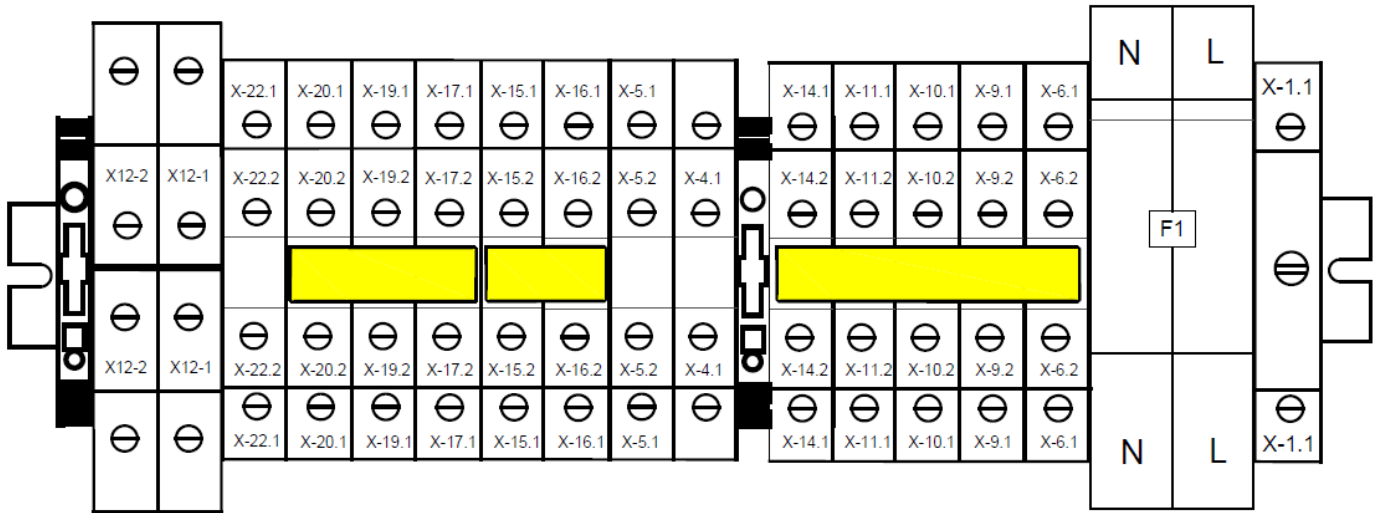

14/16 kW

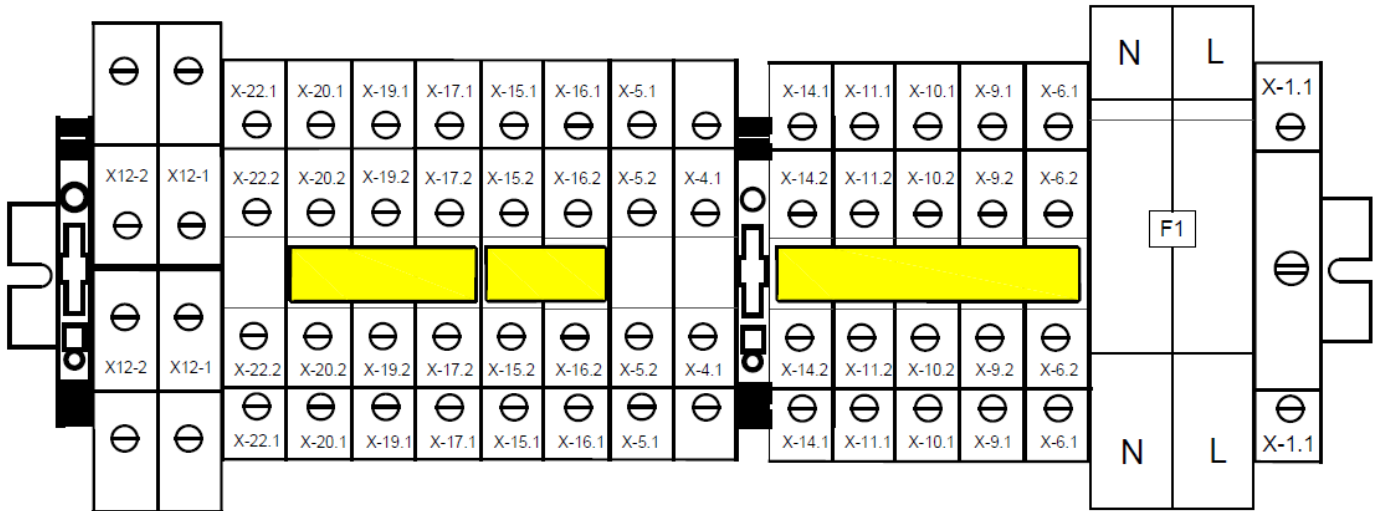

14/16/18 kW 3ph

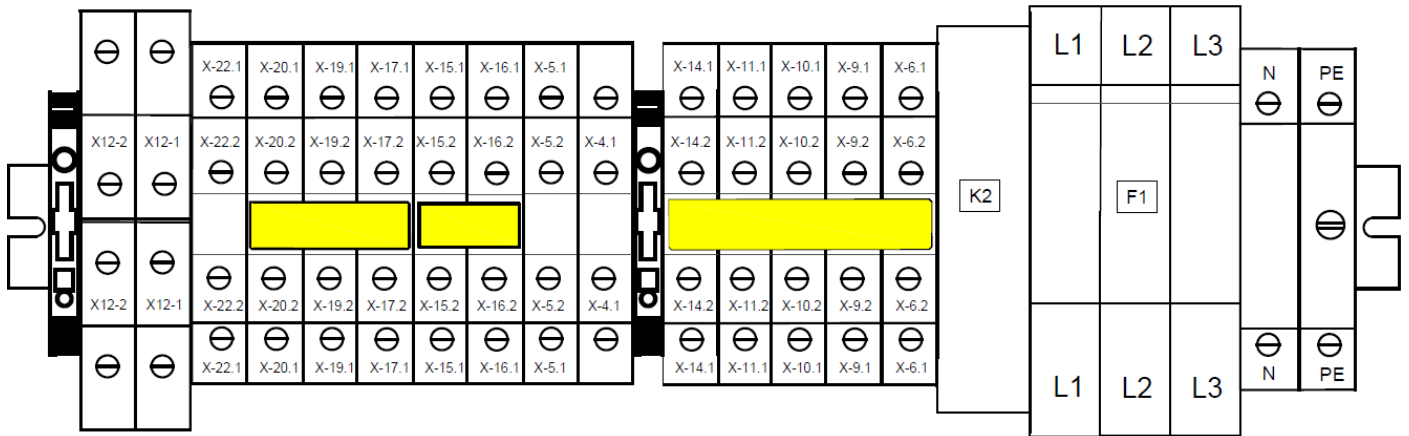

5.7.4 Control logics

For the control logics, see the manual cod. MCO01110L8500.

5.7.5 Fuses

Details on the type and nominal specifications of the fuses are set out on the machine's data plate, as well as on the fuses.

6 STARTUP

Before start-up:

- Check that the diagrams and manuals of the installed machine are available.
- Check that the wiring and plumbing diagrams of the plant the machine is connected to are available.
- Check that the shut-off valves of the water circuits are open.
- Check that the water circuit was filled under pressure and the air vented.
- Check that all the plumbing connections are installed correctly and that all the indications on the rating plates are complied with.
- Make sure that measures have been taken to discharge condensate.
- Check the electrical connection and correct fastening of all the terminals.
- Check that the electrical connections have been made according to standards in force, including earthing.
- Voltage must match that on the unit's rating plate.
- Make sure that the electric voltage is within the tolerance limits ($\pm 5\%$).
- Check that the electric heaters of the compressors are properly powered.
- Check that there are no gas leaks.
- Before switching the unit on, check that all panels are positioned correctly and well-fixed with screws.



CAUTION: *The unit must be connected to the electric mains and placed in STANDBY (powered on) by closing the master switch at least 12 hours before start-up. This will allow the heaters to adequately warm up the compressor crankcase (the heaters are powered automatically when the switch is closed). The heaters are working properly if after a few minutes the temperature of the compressor crankcase is 10-15°C higher than ambient temperature.*

CAUTION: *check that the weight of the pipes does not bear upon the machine structure.*

CAUTION: *Never use the master switch to stop the unit temporarily. This must only be done to disconnect the unit from the power supply for long downtimes (e.g. seasonal stops etc.). Furthermore, power is missing; the crankcase heaters will not be powered with the risk of breaking the compressors when the unit is switched on.*

	CAUTION: Do not modify the electrical connections of the unit so as not to immediately terminate the warranty.
	CAUTION: Summer/winter operation must be selected at the start of the relative season. Frequent and sudden changes of this operation must be avoided so as not to damage the compressors.
	CAUTION: Upon initial installation and start-up, make sure that the machine works properly both in heating and cooling mode.

6.1 SWITCHING ON THE UNIT

To supply power to the machine, turn the external handle of the disconnecter to ON (“I”).

The unit display only switches on if the phase sequence is correct (inspection to be made when commissioning the unit).

Wait at least 1 minute between switching the unit off and back on again.

7 INSTRUCTIONS FOR THE USER

Write down the unit’s identification data to be able to give it to the assistance centre when requesting an intervention.

	<i>The identification plate applied on the machine has all of the technical and performance data of the appliance.</i>
	<i>In case of tampering, removal or deterioration, ask the Technical Assistance Service for a copy.</i>
	<i>Tampering, removal and deterioration of the identification plate complicates installation, maintenance and request for spare parts.</i>

We recommend keeping track of the interventions carried out on the unit to make any troubleshooting easier.

In case of failure or malfunctioning:

- check the type of alarm triggered to report it to the assistance centre;
- contact an authorised assistance centre;
- if requested by the assistance centre, immediately deactivate the unit without resetting the alarm;
- Request that original spare parts be used.

8 SHUTDOWNS FOR LONG PERIODS



The shutdown mode of the plant depends on the site of application and the time the plant is expected to be shut down. If the unit is equipped with the antifreeze system, even when off (system on unit at “off” position),

	<i>The anti-freeze system remains in operation if the continuity of electrical supply to the appliances is guaranteed.</i>
--	---











If the system is expected to remain idle for a long period, it is recommended to empty the liquid from the system unless there is an adequate amount of glycol.

To switch off the unit completely after having emptied the system:

- Switch off the unit setting the switch of each appliance at “OFF”.
- Close the water valves
- Set the general residual current device at “OFF” (if installed upstream of the system).

	<i>If the temperature drops below zero, there is serious danger of frost: provide a mixture of water and glycol in the system, otherwise drain the water system and the circuits of the heat pump.</i>
	<i>CAUTION: even the transient operation, with water temperatures below +5°C is not guaranteed based on the limits established in Paragraph 12.4. Before you turn the unit back on after a long idle period, make sure that the temperature of the mixture of water and glycol is higher than or at least equal to +5°C.</i>

9 MAINTENANCE AND PERIODIC CHECKS

	<i>CAUTION: All the operations described in this chapter MUST BE CARRIED OUT BY QUALIFIED PERSONNEL ONLY. Before performing any intervention on the unit or accessing internal parts, make sure you have disconnected power.</i>
	<i>CAUTION: Before starting to operate, safety checks must be performed to ensure the combustion hazard is reduced to the minimum. The work must be undertaken according to a controlled procedure, to reduce to the minimum the risk of flammable gases or vapours while performing the work. The area must be checked with an appropriate refrigerant fluid detector before and during the work.</i>
	<i>Maintenance must only be carried out in weather conditions suitable for the operations envisaged.</i>
	<i>ATTENTION: it is possible that a certain quantity of oil from the compressor is deposited in the pipes of the refrigeration circuit, especially by bends. In case of maintenance operations in which it is necessary to unsolder the pipes, it is strongly recommended to proceed with the cutting of the same and not with the disordering with a torch, as the flame triggers any oil present.</i>
	<i>It is prohibited to fill the refrigerant circuits with a refrigerant other than that indicated on the identification plate. Using a different refrigerant can cause serious damage to the compressor.</i>
	<i>It is prohibited to use oils other than those indicated in this manual. Using a different oil can cause serious damage to the compressor</i>
	<i>The heads and delivery pipe of the compressor are normally quite hot.</i>
	<i>Be careful when working near the condensing coils. The aluminium fins are very sharp and can cause serious injuries. Always use appropriate personal protective equipment.</i>
	<i>After the maintenance operations, close the panels by fixing them with screws. Pay particular attention to the correct closing of the electrical panel box.</i>
	<i>After the maintenance operations, pay attention to the correct tightening of the cable gland designed for the passage of the electric power cable.</i>
	<i>It is recommended to have specialised personnel perform periodical inspections and maintenance. The EU regulation n.517/2014 establishes that users must perform regular inspections on the plants, checking water tightness and eliminating any leaks as quickly as possible. Verify the mandatory nature and the documentation required in regulation n.517/2014 and its subsequent amendments or repeals.</i>

As the manufacturer, we recommend that the following service plan be maintained (if necessary, carried out by a specialist company). Non-compliance can have a negative effect on error-free operation and the expected product service life of the heat pump.

OPERATION	1 month	4 months	6 months	12 months
Filling the water circuit.	x			
Presence of bubbles in the water circuit.	x			
Check the proper working of the safety and control devices.	x			
Check that there are no oil leaks from the compressor.	x			
Check if there is a possible water leakage from the water circuit.	x			
Check that the flow switch works properly.	x			

Check that the crankcase heaters are powered and running.	x			
Clean the metal filters of the water circuit.	x			
Clean the finned coil with compressed air or water jet		x		
Check that the electric terminals both inside the electric panel and in the terminal blocks of the compressor are well tightened.		x		
Tightening of plumbing connections.		x		
Check fixing and balancing of the fans.		x		
Clean the air filters in the electrical panel or replace them if necessary		x		
Correct electric voltage and phase imbalance (without load and under load).			x	
Correct absorption.			x	
Check the refrigerant charge and eventual leaks			x	
Check the operating pressure, superheating and sub-cooling.			x	
Circulation pump efficiency.			x	
If the unit should be out of service for a long period, drain water from the pipes and from the heat exchanger. This operation is necessary if, during seasonal stoppages, ambient temperature is expected to go down below the freezing point of the employed fluid.			x	
Check for corrosion/oxidation				x
Check panel fastening				x
Check the water quality (see chapter Characteristics of the system water) and the possible concentration of glycol			x	
Check the pressure drops of any filter driers on the liquid line			x	
Check the hydronic side safety valve			x	

9.1 CLEANING THE FINNED COIL

To correctly clean the coil, follow the instructions below:

- a) Remove any superficial filth. Debris such as leaves, fibres etc. must be removed without a vacuum cleaner (use a brush or another soft tool carefully avoiding scratching with metal or abrasive parts). If you use compressed air, pay attention to keep the airflow perpendicular to the surface of the coil in order not to bend the aluminium fins. Pay attention not to bend the fins with the nozzle of the compressed air lance.
- b) Rinse. Rinse with water. It is possible to use chemical substances (specific detergents for finned coils). Rinse the coils by letting the water run inside each individual passage of the fins, until they are perfectly clean. Pay attention to direct the water jet perpendicular to the surface of the coil in order not to bend the aluminium fins. Do not strike the coil with the water hose. Apply your thumb at the end of the hose to increase the pressure of the water jet instead of using specific nozzles, which could damage the coil.

9.1.1 Cleaning the finned coils with the anti-corrosion method

The anti-corrosion treatment applied to the finned coils (available as an alternative to the standard coils) guarantees protection against aggressive atmospheres.

The frequency of cleaning depends on the environmental conditions and is left to the common sense of the maintenance staff. When oxidizing dust or grease particles are observed on the battery surface, cleaning is recommended. In general, in a slightly polluted atmosphere, it is recommended to carry out the cleaning treatment every three months. Washing should be carried out with preferably hot water (40-60 ° C) and detergent with neutral pH, while rinsing is carried out with abundant fresh water (50 l / m2).

If the maintenance staff observes a lack of protective cover on the edge of the fins, it is necessary to contact the nearest service centre to proceed with a new application of the cover and completely restore the protection against corrosion

	<p><i>CAUTION: Do not clean the coil using high-pressure cleaners so as not to apply excessive pressure, which could cause irreparable damage. Damage caused by cleaning with unsuitable chemical substances or excessively high water pressure will not be recognised under warranty.</i></p>
	<p><i>CAUTION: The aluminium fins are thin and sharp. Pay the utmost attention and use appropriate PPE to avoid cuts and abrasions. Cover your eyes and face appropriately to avoid squirting water and filth while blowing. Wear waterproof shoes or boots and clothing covering your entire body.</i></p>
	<p><i>For units installed in aggressive atmospheres with a high fouling rate, cleaning of the coil must be part of the routine maintenance program. In these types of installations, all of the dust and particulates deposited on the coils must be removed as soon as possible through regular cleaning according to the methods shown above.</i></p>

9.1 CLEANING OF EXTERNAL SURFACES

The sheets of the outer casing must be properly cleaned to avoid the accumulation of dust / dirt, preventing the onset of corrosion. The painting ensures resistance to atmospheric agents but it is good practice to make sure to remove any dirt present, cleaning the surfaces with neutral detergent and water, especially if the unit is installed in places with an aggressive atmosphere (high level of pollution, salt, etc.).

9.2 EXTRAORDINARY MAINTENANCE

An authorised assistance centre must carry out all extraordinary maintenance jobs.



10 DECOMMISSIONING

Once the unit has reached the end of its life cycle and needs to be replaced, the following operations are recommended:

- the refrigerant has to be recovered by trained personnel and sent to proper collection centres; according to the procedures indicated in Regulation No. 517/2014 on fluorinated greenhouse gases;
- any antifreeze additives in the water circuit must be recovered and disposed of properly;
- the compressors' lubricating oil has to be collected and sent to proper collection centres;
- the electronic components, such as regulators, driver boards and inverters, must be disassembled and sent to proper collection centres;
- The structure and the different components, if unusable, must be scrapped and divided according to their nature; there is especially a good amount of copper and aluminium in the machine.

These operations allow easy material recovery and the recycling process, thus reducing the environmental impact in accordance with the provisions of Directive 2012/19 / EU on waste electrical and electronic equipment (RAEE).

The user is responsible for the proper disposal of this product, according to national regulations in the country of destination of the appliance. For more information, you should contact the Installation Company or local competent authority.

	<p><i>An incorrect decommissioning of the appliance may create serious environmental damage and endanger people's safety. Therefore, it is recommended that only authorised persons with technical training who have attended training courses acknowledged by the competent authorities dispose the unit.</i></p>
	<p><i>It is required to follow the same precautions described in the previous paragraphs.</i></p>
	<p><i>Pay special attention during disposal of the refrigerant gas.</i></p>
	<p><i>The illegal disposal of the product by the end user leads to the application of the penalties in accordance with the law in the country where the disposal takes place.</i></p>
 	<p><i>The crossed-out bin symbol applied on the appliance indicates that the product, at the end of its useful life, <u>must be collected separately from other solid/municipal waste.</u></i></p>
	<p><i>The units are manufactured in accordance with the EC directive on waste of electric/electronic equipment and the harmful effects of incorrect disposal are provided in the user/installer manual.</i></p>
	<p><i>The manufacturing company or its importer/retailer is available to respond to any requests for additional information.</i></p>

10.1 Residual risks

This paragraph sets forth any residual risks, which cannot be eliminated by the manufacturer in the design stage.

Risk due to:	Precautions/Corrections
Handling	There is always the risk of the unit falling or tipping over during handling. Follow the instructions in the "Handling" section and take all of the precautions foreseen according to local regulations.
Installation	Unsuitable installation can cause water leaks, gas leaks, electric shocks, fire hazards, malfunctioning or damage of the unit. Only qualified technical personnel can perform installation. Place the unit in an appropriate area and without the risk of flammable gas leaks. Make the installation zone inaccessible to third parties.
Dust/Water in the electric panel	Fasten the panel of the electrical switchgear correctly. Any infiltrations can cause shocks and short-circuits causing personal harm and damage to property or to the unit itself. Pay special attention to the earthing connection.
Maintenance	During maintenance, which must always be carried out by authorised personnel, make sure that the disconnecter is off and that no one can accidentally modify the disconnection measures of the appliance from the unit by means of specific warnings and an adequate padlock.
Fan	Contact with the fan can cause injury and/or death. Do not access the unit or remove the protections while the fan is running.
Refrigerant gas leakage	Wear suitable PPE as a gas leakage could cause injury and intoxication. Carefully read the "Safety data sheet of the refrigerant" included in the manual. Do not make use of heat sources near the circuit before it is completely discharged.
Water leaks	These can cause personal harm and property damage and risk a short circuit. We recommend positioning the shut-off valves.

- Every person working on the refrigerant circuit must be able to produce a certificate of competence issued by an organisation with industry accreditation. This certificate confirms their competence in the safe handling of refrigerants by means of a standard industry procedure.
- Servicing work may only be carried out in accordance with the manufacturer's specifications. If maintenance and repair work requires assistance from additional individuals, the person trained in the handling of flammable refrigerants must constantly supervise the work.
- In order to minimise the risk of ignition, safety checks must be carried out before any work on appliances with flammable refrigerants can commence. Take the following measures **before** interfering with the refrigerant circuit:

Measure	Completed	Notes
<p>1 General working environment</p> <ul style="list-style-type: none"> ▪ Inform the following persons of the type of work to be carried out: <ul style="list-style-type: none"> – All maintenance personnel – All persons near the system. ▪ Cordon off the area around the heat pump. ▪ Survey the immediate surroundings of the heat pump for flammable materials and sources of ignition: Remove all flammable materials and sources of ignition. 		
<p>2 Checking for the presence of refrigerant</p> <ul style="list-style-type: none"> ▪ In order to recognise a flammable atmosphere in time: Before, during and after the work, check the surrounding area for any escaping refrigerant, using an explosion-proof refrigerant detector suitable for R32. This refrigerant detector must not generate any sparks and must be suitably sealed. 		
<p>3 Fire extinguisher</p> <p>A CO₂ or powder extinguisher must be at hand in the following cases:</p> <ul style="list-style-type: none"> ▪ Refrigerant is being topped-up. ▪ Welding or brazing/soldering work is being carried out. 		
<p>4 Sources of ignition</p> <ul style="list-style-type: none"> ▪ When carrying out work on a refrigerant circuit that contains or previously contained flammable refrigerant, never use sources of ignition that could ignite the refrigerant. Remove all possible sources of ignition, including cigarettes, from the area where installation, repair, dismantling or disposal work is taking place that may result in refrigerant escaping. ▪ Before starting work, survey the immediate surroundings of the heat pump for flammable materials and sources of ignition: Remove all flammable materials and sources of ignition. ▪ Display no smoking signs. 		
<p>5 Ventilating the work location</p> <ul style="list-style-type: none"> ▪ Carry out repairs outdoors, or provide adequate ventilation for the work location before interfering with the refrigerant circuit or commencing any welding or brazing/soldering work. ▪ The ventilation must be maintained for the entire duration of the work. The ventilation should dilute any refrigerant that may escape and should ideally discharge it to atmosphere. 		

Measure	Completed	Notes
<p>6 Checking the refrigeration system</p> <ul style="list-style-type: none"> ▪ Any replacement electrical components must be suitable for the application and must correspond to the manufacturer's specification. Only replace faulty components with genuine spare parts. ▪ Carry out all component replacements in accordance with guidelines. If necessary, consult Worker technical services. <p>Perform the following checks:</p> <ul style="list-style-type: none"> ▪ The refrigerant charge must not be greater than permitted for the installation room. ▪ Check the function of the ventilation system. The ventilation apertures must not be blocked or obstructed. ▪ If a hydraulically separated system is used, check the secondary circuit for the presence of any refrigerant. ▪ Labels and symbols must always be clearly visible and legible. Replace any illegible information. ▪ Refrigerant lines and components must be installed in such a manner that they meet substances that can cause corrosion. Exception: The refrigerant lines are made from corrosion-resistant materials or are reliably protected against corrosion. 		
<p>7 Checks on electrical components</p> <ul style="list-style-type: none"> ▪ Safety checks must be carried out for maintenance and repair work on electrical components: See below. ▪ In the event of a safety-related fault, do not connect the system until the fault has been remedied. If it is not possible to remove the fault immediately, provide a suitable interim solution for the system's operation if required. Inform the system operator. <p>Carry out the following safety checks:</p> <ul style="list-style-type: none"> ▪ Discharge the capacitors: Ensure no sparks are created when discharging. ▪ Do not position any live electrical components or cables in the immediate vicinity of the appliance when filling or extracting refrigerant or when flushing the refrigerant circuit. ▪ Check the earth connection. 		

Measure	Completed	Notes
<p>8 Repairs on sealed enclosures</p> <ul style="list-style-type: none"> ▪ When carrying out work on sealed components, fully isolate the appliance from the power supply, also before removing sealed covers. ▪ If a power, supply is necessary during the work: Position a continuously operating refrigerant detector in the most critical locations, to provide warning of any potentially dangerous situation. ▪ Pay special attention to ensuring that any work on electrical components does not lead to any changes to the enclosures that would affect their protective properties. This includes damage to leads, too many connections on a single terminal, connections that do not correspond to the manufacturer's specification, damage to seals, as well as incorrect installation of cable entries. ▪ Ensure the appliance is correctly installed. ▪ Check that the seals have settled. Ensure by checking that the seals reliably prevent the ingress of a flammable atmosphere. Replace defective seals. <p>! Please note Silicone as a sealant can affect the function of leak detection devices. Do not use silicone as a sealant.</p> <ul style="list-style-type: none"> ▪ Spare parts must correspond to the manufacturer's specifications. ▪ Work on components which are suitable for flammable atmospheres: It is not imperative that these components are isolated from the power supply. 		
<p>9 Repairs on components that are suitable for flammable atmospheres</p> <ul style="list-style-type: none"> ▪ Do not connect any continuous capacitive or inductive loads to the appliance, unless it has been ensured that the permissible voltages and currents are not exceeded. ▪ In areas where flammable atmospheres exist, only apply voltage to components, which are suitable for flammable atmospheres. ▪ Only use original parts or parts approved. Other parts may result in refrigerant becoming ignited in the event of a leak. 		
<p>10 Wiring</p> <ul style="list-style-type: none"> ▪ Check whether the wiring is subject to wear, corrosion, tension, vibration, sharp edges or other unfavourable environmental influences. ▪ When checking, also take into account the effects of ageing and continuous vibration on the compressor and fans. 		
<p>11 Refrigerant detectors</p> <ul style="list-style-type: none"> ▪ On no account use possible sources of ignition for refrigerant detection or leak detection. ▪ Flame leak detectors or other detectors with open flames must not be used. 		

Measure	Completed	Notes
<p>12 Leak detection</p> <p>The following leak detection processes are suitable for systems with flammable refrigerants:</p> <p>Leak detection with electronic refrigerant detectors:</p> <ul style="list-style-type: none"> ▪ Electronic refrigerant detectors may not have the required sensitivity or may need to be calibrated to the relevant range. Carry out the calibration in refrigerant-free surroundings. ▪ The refrigerant detector must be suitable for the R32 refrigerant to be detected. ▪ The refrigerant detector must not contain any potential sources of ignition. ▪ Calibrate the refrigerant detector to the refrigerant used. Set the response threshold to < 3 g/a, suitable for propane. <p>Leak detection with liquid leak detectors:</p> <ul style="list-style-type: none"> ▪ Liquid leak detectors are suitable for use with most refrigerants. <p>! Please note Liquid leak detectors containing chlorine may react with the refrigerant. This could result in corrosion. Do not use liquid leak detectors that contain chlorine.</p> <p>Measures to take if a leak in the refrigerant circuit occurs:</p> <ul style="list-style-type: none"> ▪ Immediately extinguish all open flames in the vicinity of the heat pump. ▪ If brazing/soldering work needs to be undertaken to remedy the leak, always extract all the refrigerant from the refrigerant circuit. Purge the site to be brazed/soldered before and during the brazing/soldering work with oxygen-free nitrogen. 		
<p>13 Extracting the refrigerant</p> <p>Removal and evacuation</p> <p>When breaking into the refrigerant circuit to make repairs – or for any other purpose – conventional procedures shall be used. However, it is important that best practice is followed since flammability is a consideration. The following procedure shall be adhered to:</p> <ul style="list-style-type: none"> - remove refrigerant; - purge the circuit with inert gas; - evacuate; - purge again with inert gas; - open the circuit by cutting or brazing. <p>The refrigerant charge shall be recovered into the correct recovery cylinders. The system shall be “flushed” with OFN to render the unit safe. This process may need to be repeated several times. Compressed air or oxygen shall not be used for this task.</p> <p>Flushing shall be achieved by breaking the vacuum in the system with OFN and continuing to fill until the working pressure is achieved, then venting to atmosphere, and finally pulling down to a vacuum. This process shall be repeated until no refrigerant is within the system. When the final OFN charge is used, the system shall be vented down to atmospheric pressure to enable work to take place. This operation is absolutely vital if brazing operations on the pipework are to take place.</p> <p>Ensure that the outlet for the vacuum pump is not close to any ignition sources and there is ventilation available.</p>		
<p>14 Topping up the refrigerant</p> <p>Charging procedures</p> <p>In addition to conventional charging procedures, the following requirements shall be followed.</p> <ul style="list-style-type: none"> – Ensure that contamination of different refrigerants does not occur when using charging equipment. Hoses or lines shall be as short as possible to minimise the amount of refrigerant contained in them. 		

	<ul style="list-style-type: none"> - Cylinders shall be kept upright. - Ensure that the refrigeration system is earthed prior to charging the system with refrigerant. - Label the system when charging is complete (if not already). - Extreme care shall be taken not to overfill the refrigeration system. <p>Prior to recharging the system it shall be pressure tested with OFN. The system shall be leak tested on completion of charging but prior to commissioning. A follow up leak test shall be carried out prior to leaving the site</p>		
15	<p>Decommissioning</p> <p>Before carrying out this procedure, it is essential that the technician is completely familiar with the equipment and all its detail. It is recommended good practice that all refrigerants are recovered safely. Prior to the task being carried out, an oil and refrigerant sample shall be taken in case analysis is required prior to re-use of reclaimed refrigerant. It is essential that electrical power is available before the task is commenced.</p> <p>a) Become familiar with the equipment and its operation.</p> <p>b) Isolate system electrically.</p> <p>c) Before attempting the procedure ensure that:</p> <ul style="list-style-type: none"> - mechanical handling equipment is available, if required, for handling refrigerant cylinders; - all personal protective equipment is available and being used correctly; - the recovery process is supervised at all times by a competent person; - recovery equipment and cylinders conform to the appropriate standards. <p>d) Pump down refrigerant system, if possible.</p> <p>e) If a vacuum is not possible, make a manifold so that refrigerant can be removed from various parts of the system.</p> <p>f) Make sure that cylinder is situated on the scales before recovery takes place.</p> <p>g) Start the recovery machine and operate in accordance with manufacturer's instructions.</p> <p>h) Do not overfill cylinders. (No more than 80 % volume liquid charge).</p> <p>i) Do not exceed the maximum working pressure of the cylinder, even temporarily.</p> <p>j) When the cylinders have been filled correctly and the process completed, make sure that the cylinders and the equipment are removed from site promptly and all isolation valves on the equipment are closed off.</p> <p>k) Recovered refrigerant shall not be charged into another refrigeration system unless it has been cleaned and checked.</p>		
16	<p>Identification (labelling the heat pump)</p> <p>If the heat pump has been taken out of use, affix a label to the heat pump in a clearly visible position containing the following information with date and signature:</p> <ul style="list-style-type: none"> ▪ Refrigerant is flammable. ▪ The system has been taken out of use. ▪ The refrigerant has been removed. 		
17	<p>Recovering the refrigerant and compressor oil</p> <p>Recovery</p> <p>When removing refrigerant from a system, either for servicing or decommissioning, it is recommended good practice that all refrigerants are removed safely.</p> <p>When transferring refrigerant into cylinders, ensure that only appropriate refrigerant recovery cylinders are employed. Ensure that the correct number of cylinders for holding the total system charge</p>		

<p>are available. All cylinders to be used are designated for the recovered refrigerant and labelled for that refrigerant (i.e. special cylinders for the recovery of refrigerant). Cylinders shall be complete with pressure relief valve and associated shut-off valves in good working order. Empty recovery cylinders are evacuated and, if possible, cooled before recovery occurs.</p> <p>The recovery equipment shall be in good working order with a set of instructions concerning the equipment that is at hand and shall be suitable for the recovery of flammable refrigerants.</p> <p>In addition, a set of calibrated weighing scales shall be available and in good working order. Hoses shall be complete with leak-free disconnect couplings and in good condition. Before using the recovery machine, check that it is in satisfactory working order, has been properly maintained and that any associated electrical components are sealed to prevent ignition in the event of a refrigerant release. Consult manufacturer if in doubt.</p> <p>The recovered refrigerant shall be returned to the refrigerant supplier in the correct recovery cylinder, and the relevant Waste Transfer Note arranged. Do not mix refrigerants in recovery units and especially not in cylinders.</p> <p>If compressors or compressor oils are to be removed, ensure that they have been evacuated to an acceptable level to make certain that flammable refrigerant does not remain within the lubricant. The evacuation process shall be carried out prior to returning the compressor to the suppliers. Only electric heating to the compressor body shall be employed to accelerate this process. When oil is drained from a system, it shall be carried out safely.</p>		
--	--	--

11 TECHNICAL DATA

11.1 TECHNICAL SHEET

TECHNICAL SPECIFICATIONS		Unit of measurement	Vitocal 100-A			
			AWO-M-AC 101.A06	AWO-M-AC 101.A08	AWO-M-AC 101.A10	AWO-M-AC 101.A12
Cooling	Cooling capacity (1) min/nom/max	kW	3.20 / 5.02 / 5.52*	3.80 / 6.08 / 6.69*	4.66 / 7.53 / 8.2*	4.55 / 8.51 / 9.36*
	Input power (1)	kW	1.60	1.99	2.39	2.79
	E.E.R. (1)	W/W	3.14	3.05	3.15	3.05
	Cooling capacity (2) min/nom/max	kW	4.82 / 6.18 / 6.80*	4.91 / 7.72 / 8.49*	6.22 / 9.50 / 10.45*	6.41 / 11.60 / 12.76*
	Input power (2)	kW	1.28	1.76	2.15	2.79
	E.E.R. (2)	W/W	4.82	4.38	4.41	4.16
	SEER (5)	W/W	4.12	4.25	4.15	4.25
	Water flow rate (1)	L/s	0.24	0.28	0.36	0.41
	User side heat exchanger pressure drops (1)	kPa	2.0	2.8	6.9	8.8
	Nominal useful head (1)	kPa	78.8	76.0	68.9	63.4
Heating	Heating capacity (3) min/nom/max	kW	3.95 / 6.08 / 6.99*	3.95 / 7.81 / 8.98*	5.33 / 10.10 / 11.62*	5.33 / 11.80 / 13.57*
	Input power (3)	kW	1.35	1.78	2.28	2.73
	C.O.P. (3)	W/W	4.51	4.38	4.43	4.32
	Heating capacity (4) min/nom/max	kW	3.82 / 5.88 / 6.76*	3.80 / 7.58 / 8.72*	5.18 / 9.76 / 11.22*	5.13 / 11.47 / 13.19*
	Input power (4)	kW	1.66	2.17	2.80	3.33
	C.O.P. (4)	W/W	3.54	3.50	3.48	3.44
	SCOP (6)	W/W	4.46	4.46	4.53	4.47
	Water flow rate (4)	L/s	0.28	0.37	0.47	0.55
	User side heat exchanger pressure drops (4)	kPa	2.1	3.3	9.7	13.1
	Nominal useful head (4)	kPa	75.8	66.3	55.2	43.4
Energy efficiency water 35°C / 55°C	Class	A+++/A++	A+++/A++	A+++/A++	A+++/A++	
Compressor	Type		Twin Rotary DC Inverter	Twin Rotary DC Inverter	Twin Rotary DC Inverter	Twin Rotary DC Inverter
	Refrigerant oil (type)		ESTEL OIL RB74AF	ESTEL OIL RB74AF	ESTEL OIL VG74	ESTEL OIL VG74
	Number of compressors		1	1	1	1
	Oil charge (amount)	L	0.67	0.67	1	1
	Refrigerant circuits		1	1	1	1
Refrigerant	Type		R32	R32	R32	R32
	Refrigerant charge (7)	kg	1.5	1.5	2.5	2.5
	Amount of refrigerant in equivalent CO ₂ tonnes (7)	ton	1.0	1.0	1.7	1.7
	Design pressure (high/low) heat pump mode	bar	42.8/1.3	42.8/1.3	42.8/1.3	42.8/1.3
	Design pressure (high/low) chiller mode	bar	42.8/3.5	42.8/3.5	42.8/3.5	42.8/3.5
External zone fans	Type		DC Brushless motor	DC Brushless motor	DC Brushless motor	DC Brushless motor
	Number		1	1	1	1
Internal heat exchanger	Internal heat exchanger type					
	No. internal heat exchangers		1	1	1	1
Water circuit	Water content	L	0.9	0.9	1.2	1.2
	Water content of hydronic circuit	L	1.4	1.4	1.8	1.8
	Maximum water side pressure	bar	6	6	6	6
	Plumbing fittings	inch	1" M	1" M	1" M	1" M
	Minimum water volume	L	40	40	50	60
	Nominal circulator output	kW	0.075	0.075	0.075	0.075
	Maximum circulator output	kW	0.075	0.075	0.075	0.075
	Max circulator absorbed current	A	0.38	0.38	0.38	0.38
Energy Efficiency Index (EEl) circulator		≤ 0.21	≤ 0.21	≤ 0.21	≤ 0.21	
Noise level	Sound power level L _w (8)	dB(A)	64	64	64	65
	Sound pressure level at a distance of 1m L _{p1} (9)	dB(A)	49.8	49.8	49.4	50.4
	Sound pressure level at a distance of 10m L _{p10} (9)	dB(A)	32.8	32.8	32.7	33.7
Electrical data	Power supply		230V/1/50Hz			
	Maximum input power	kW	3.5	3.9	4.6	5.1
	Maximum input current	A	15.1	17.0	20.2	22.1
	Maximum input power with antifreeze kit	kW	3.6	4.0	4.8	5.2
Dimensions and weights	Maximum input current with antifreeze kit	A	15.6	17.6	20.7	22.7
	A - Length	mm	924	924	1047	1047
	B - Depth	mm	377	377	455	455
	C - Height	mm	828	828	936	936
	Shipping weight	kg	84	84	110	110
Operating weight	kg	72	72	96	96	

TECHNICAL SPECIFICATIONS		Unit of measurement	Vitocal-100A				
			AWO-M-AC 101.A14	AWO-AC 101.A14	AWO-M-AC 101.A16	AWO-AC 101.A16	AWO-AC 101.A18
Cooling	Cooling capacity (1)	kW	6.87 / 11.48 / 12.05*	6.87 / 11.48 / 12.05*	5.99 / 13.80 / 14.49*	5.99 / 13.80 / 14.49*	6,86 15,04 / 15,79*
	min/nom/max						
	Input power (1)	kW	3.53	3.53	4.38	4.38	4,88
	E.E.R. (1)	W/W	3.25	3.25	3.15	3.15	3,08
	Cooling capacity (2)	kW	9.17 / 14.00 / 14.70*	9.17 / 14.00 / 14.70*	9.20 / 15.80 / 16.59*	9.20 / 15.80 / 16.59*	9,09 / 17,10 / 17,96*
	min/nom/max						
	Input power (2)	kW	2.59	2.59	3.15	3.15	3,59
	E.E.R. (2)	W/W	5.40	5.40	5.02	5.02	4,76
	SEER (5)	W/W	4.62	4.62	4.80	4.80	4,91
	Water flow rate (1)	L/s	0.55	0.55	0.66	0.66	0,71
User side heat exchanger pressure drops (1)	kPa	12.9	12.9	17.5	17.5	20,6	
Nominal useful head (1)	kPa	75.0	75.0	62.3	62.3	55,6	
Heating	Heating capacity (3)	kW	7.54 / 14.10 / 15.23*	7.54 / 14.10 / 15.23*	7.36 / 16.30 / 17.60*	7.36 / 16.30 / 17.60*	7,30 / 17,90 / 19,33*
	min/nom/max						
	Input power (3)	kW	2.91	2.91	3.49	3.49	4,07
	C.O.P. (3)	W/W	4.85	4.85	4.67	4.67	4,40
	Heating capacity (4)	kW	7.23 / 13.56 / 14.64*	7.23 / 13.56 / 14.64*	7.06 / 15.77 / 17.03*	7.06 / 15.77 / 17.03*	7,02 / 17,32 / 18,71*
	min/nom/max						
	Input power (4)	kW	3.55	3.55	4.24	4.24	4,92
	C.O.P. (4)	W/W	3.82	3.82	3.72	3.72	3,52
	SCOP (6)	W/W	4.48	4.48	4.50	4.50	4,46
	Water flow rate (4)	L/s	0.65	0.65	0.76	0.76	0,83
	User side heat exchanger pressure drops (4)	kPa	13.0	13.0	17.6	17.6	21,0
	Nominal useful head (4)	kPa	63.6	63.6	48.5	48.5	37,3
	Energy efficiency water 35°C / 55°C	Class	A+++/A++	A+++/A++	A+++/A++	A+++/A++	A+++/A++
Compressor	Type		Twin Rotary	Twin Rotary	Twin Rotary	Twin Rotary	Twin Rotary
	Refrigerant oil (type)		DC Inverter	DC Inverter	DC Inverter	DC Inverter	DC Inverter
	Number of compressors		ESTEL OIL VG74	ESTEL OIL VG74	ESTEL OIL VG74	ESTEL OIL VG74	ESTEL OIL VG74
	Oil charge (amount)	L	1	1	1	1	1
	Refrigerant circuits		1.4	1.4	1.4	1.4	1.4
Refrigerant	Type		1	1	1	1	1
	Refrigerant charge (7)	kg	R32	R32	R32	R32	R32
	Amount of refrigerant in equivalent CO ₂ tonnes (7)	ton	3.2	3.2	3.5	3.5	3.5
	Design pressure (high/low) heat pump mode	bar	2.2	2.2	2.4	2.4	2.4
	Design pressure (high/low) chiller mode	bar	42.8/1.3	42.8/1.3	42.8/1.3	42.8/1.3	42,8/1,3
External zone fans	Type		42.8/3.5	42.8/3.5	42.8/3.5	42.8/3.5	42,8/3,5
	Number		DC Brushless motor	DC Brushless motor	DC Brushless motor	DC Brushless motor	Motor DC Brushless
Internal heat exchanger	Internal heat exchanger type		2	2	2	2	2
	No. internal heat exchangers		Plate				
	Water content	L	1	1	1	1	1
Water circuit	Water content of hydronic circuit	L	1.7	1.7	1.7	1.7	1,7
	Maximum water side pressure	bar	3.0	3.0	3.0	3.0	3,0
	Plumbing fittings	inch	6	6	6	6	6
	Minimum water volume	L	1" M	1" M	1" M	1" M	1" M
	Nominal circulator output	kW	60	60	70	70	70
	Maximum circulator output	kW	0.14	0.14	0.14	0.14	0,14
	Max circulator absorbed current	A	0.14	0.14	0.14	0.14	0,14
Energy Efficiency Index (EEI) circulator		1.10	1.10	1.10	1.10	1,10	
Noise level	Sound power level L _w (8)	dB(A)	≤ 0.23	≤ 0.23	≤ 0.23	≤ 0.23	≤ 0,23
	Sound pressure level at a distance of 1m L _{p1} (9)	dB(A)	68	68	68	68	68
	Sound pressure level at a distance of 10m L _{p10} (9)	dB(A)	52.7	52.7	52.7	52.7	52,7
Electrical data	Power supply		36.6	36.6	36.6	36.6	36,6
	Maximum input power	kW	230V/1/50Hz	400V/3P+N+T/50Hz	230V/1/50Hz	400V/3P+N+T/50Hz	400V/3P+N+T/50Hz
	Maximum input current	A	6.6	6.6	7.0	7.0	8,3
	Maximum input power with antifreeze kit	kW	28.6	9.5	30.4	10.1	12,0
	Maximum input current with antifreeze kit	A	6.7	6.7	7.1	7.1	8,5
Dimensions and weights	A - Length	mm	29.2	9.7	31.0	10.3	12,2
	B - Depth	mm	1044	1044	1044	1044	1044
	C - Height	mm	448	448	448	448	448
	Shipping weight	kg	1409	1409	1409	1409	1409
	Operating weight	kg	134	148	140	154	154
		kg	121	136	126	141	141

Performance referring to the following conditions, according to standard 14511:2018:

- (1) Cooling: outdoor air temperature 35°C; in/out water temperature 12/7°C.
- (2) Cooling: outdoor air temperature 35°C; in/out water temperature 23/18°C.
- (3) Heating: outdoor air temperature 7°C db 6°C db; in/out water temp 30/35°C.
- (4) Heating: outdoor air temperature 7°C db 6°C db; in/out water temp 40/45°C.
- (5) Cooling: in/out water temperature 7/12°C.
- (6) Heating: average climatic conditions; T_{biv}=-7°C; in/out water temp 30/35°C.
- (7) Indicative data subject to changes. For the correct value, always refer to the technical label on the unit.
- (8) Sound power level: heating mode condition (3); value determined based on measurements made in accordance with standard UNI EN ISO 9614-2, compliant with that required by the Eurovent certification.
- (9) Sound pressure level: value calculated from the sound power level using ISO 3744:2010
- (*) activating the maximum Hz function

N.B. performance data are indicative and are subject to change. Furthermore, the performance declared in points (1), (2), (3) and (4) is intended to refer to instantaneous power according to EN 14511. The value declared in point (5) and (6) is determined according to UNI EN 14825.

	CAUTION: The minimum temperature allowed for storing the units is 5°C.
--	---

11.2 UNIT AND AUXILIARY ELECTRICAL DATA

Unit power supply	V/~ /Hz	230/1PH+PE/50* - 400/3PH+PE/50**	Remote controller circuit	V/~ /Hz	12/1/50
On board controller circuit	V/~ /Hz	12/1/50	Fans power supply	V/~ /Hz	230/1/50

For sizes 06, 08, 10, 12, 14 and 16* - For sizes 14T, 16T, 18T

NOTE: The electrical data are subject to change due to updates. It is therefore always necessary to refer to the technical specifications label applied on the right side panel of the unit.

12 OPERATING LIMITS

12.1 EVAPORATOR WATER FLOW RATE

The nominal water flow rate refers to a 5°C temperature difference between the evaporator inlet and outlet. The maximum permitted flow rate features a 3°C temperature difference while the minimum one has an 8°C temperature difference at the nominal conditions as shown in the technical sheet.

	<i>Insufficient water flow rates can cause excessively low evaporation temperatures causing the safety devices to trigger and stopping the unit and, in some extreme cases, forming ice in the evaporator and resulting in serious failures to the cooling circuit.</i>
--	--

For greater details, we have attached a table below with the minimum flow rates for the plate heat exchanger to guarantee proper operation according to the model (please note: the water flow switch is applied to protect against failed triggering of the antifreeze probe due to the lack of flow but does not guarantee the minimum water flow rate required for correct operation of the unit).

Model							
	06	08	10	12	14	16	18
Minimum water flow to be assured in chiller mode (condition (1) technical sheet) [l/s]	0.15	0.17	0.23	0.25	0.34	0.34	0,41
Maximum water flow to be assured in chiller mode (condition (1) technical sheet) [l/s]	0.40	0.46	0.60	0.68	0.92	0.92	1,10
Minimum flow switch water flow rate* [l/s]	0.117	0.117	0.153	0.153	0.153	0.262	0,262
Maximum flow switch water flow rate* [l/s]	0.132	0.132	0.175	0.175	0.175	0.293	0,293

* When the flow rate drops below the indicated limit (flow switch minimum water flow rate) the flow switch issues an alarm, which may be reset only upon reaching the maximum indicated flow rate.

12.2 COLD WATER PRODUCTION (SUMMER MODE)

A minimum temperature of 5°C is allowed at the evaporator outlet: for lower temperatures, contact the Technical Department. In this case contact our technical department to study the feasibility and assess the changes to be made according to demands. A maximum temperature of 25°C can be maintained at the evaporator outlet in steady-state operation.

12.3 HOT WATER PRODUCTION (WINTER MODE)

When the system has reached steady state, the water inlet temperature must not drop below 25°C: lower values, not due to transient phases or reaching steady-state, can cause system failures and could possibly break the compressor. The maximum outlet water temperature must not exceed 60°C.

There could be failures to the regular operation of the unit or, in more critical cases, the safety devices could be triggered due to temperatures higher than those indicated, especially if coupled with reduced water flow rates.

12.4 AMBIENT AIR TEMPERATURE AND SUMMARISED TABLE

The units are designed and built to operate in summer mode, with condensation control, at outdoor air temperatures between -10°C and +46°C. In heat pump mode, the allowed temperature range of the outdoor air is from -20°C to +40°C depending on the outlet water temperature as shown in the table below.

Operating limits

Water chiller mode		
Room temperature	Minimum -10°C	Maximum +46°C
Outlet water temperature	Minimum +5°C	Maximum +25°C
Heat pump mode		
Room temperature	Minimum -20°C	Maximum +30°C
Outlet water temperature	Minimum +25°C	Maximum +60°C
Heat pump mode for domestic hot water		
Room temperature with water at maximum 39°C	Minimum -20°C	Maximum +40°C
Room temperature with water at maximum 55°C	Minimum -10°C	Maximum +35°C
Outlet water temperature	Minimum +25°C	Maximum +60°C

The following are the graphical operating limits for air-conditioning and domestic hot water production.

HEAT PUMP MODE

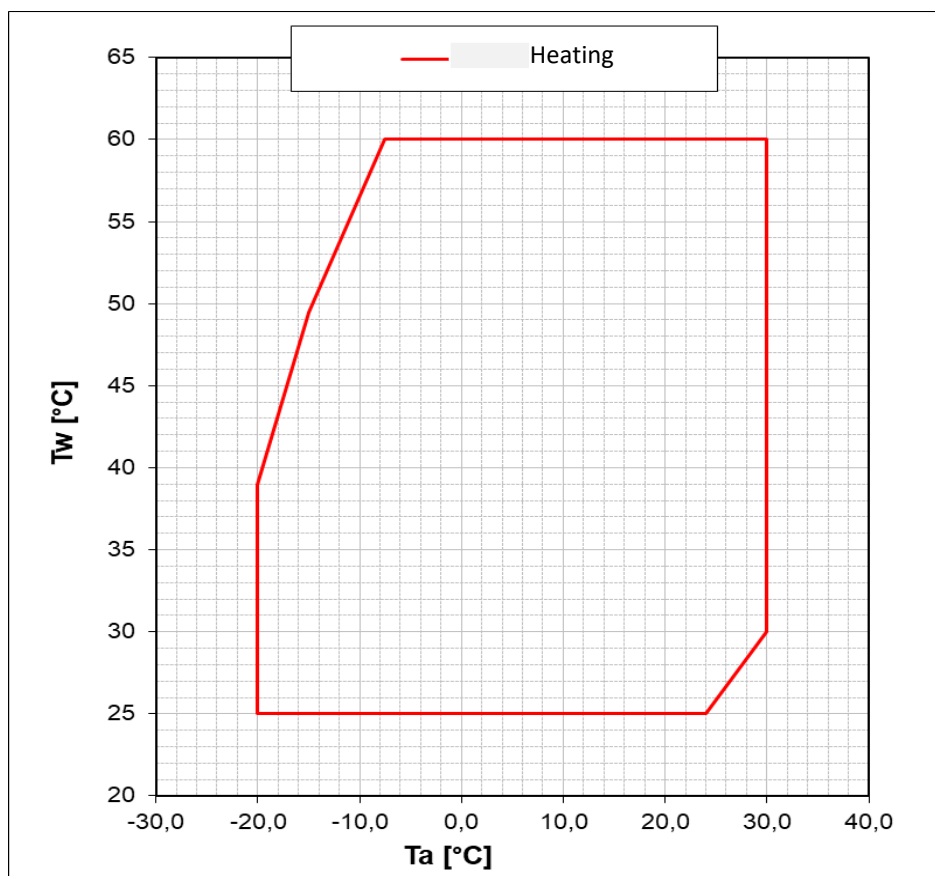

CHILLER MODE

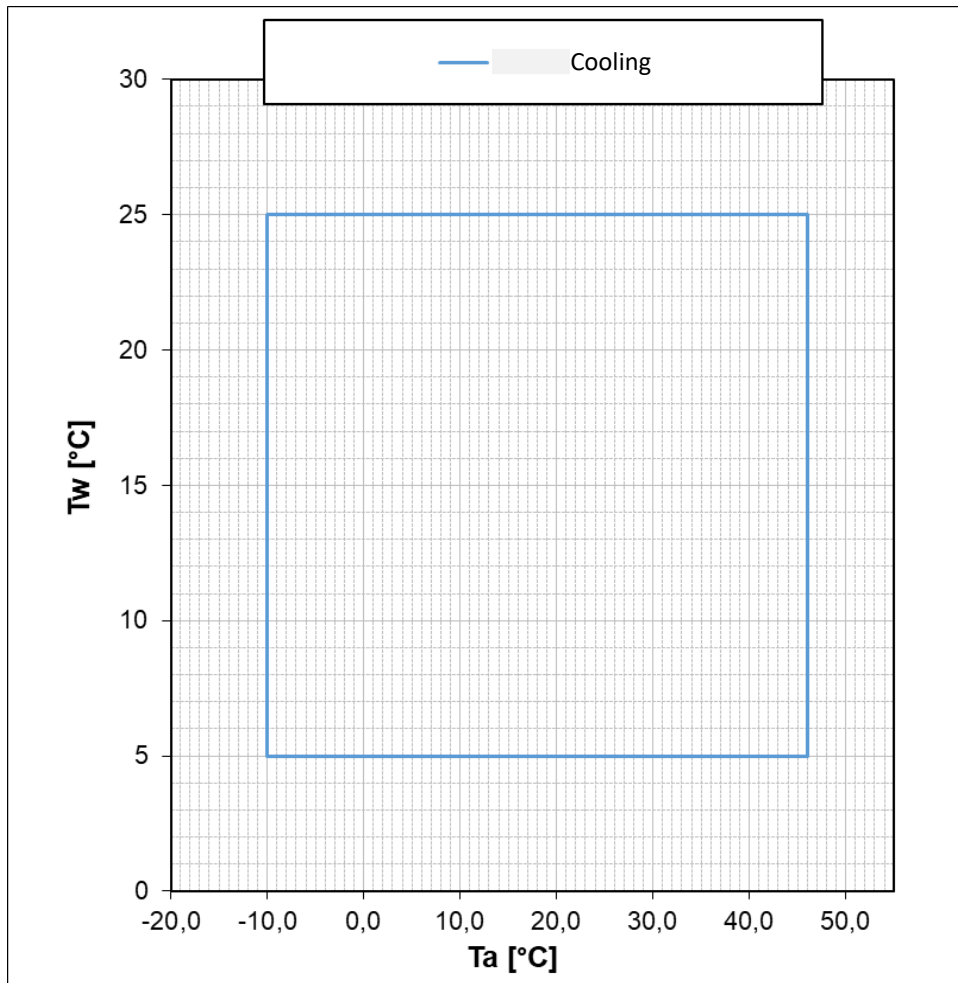

DOMESTIC HOT WATER MODE

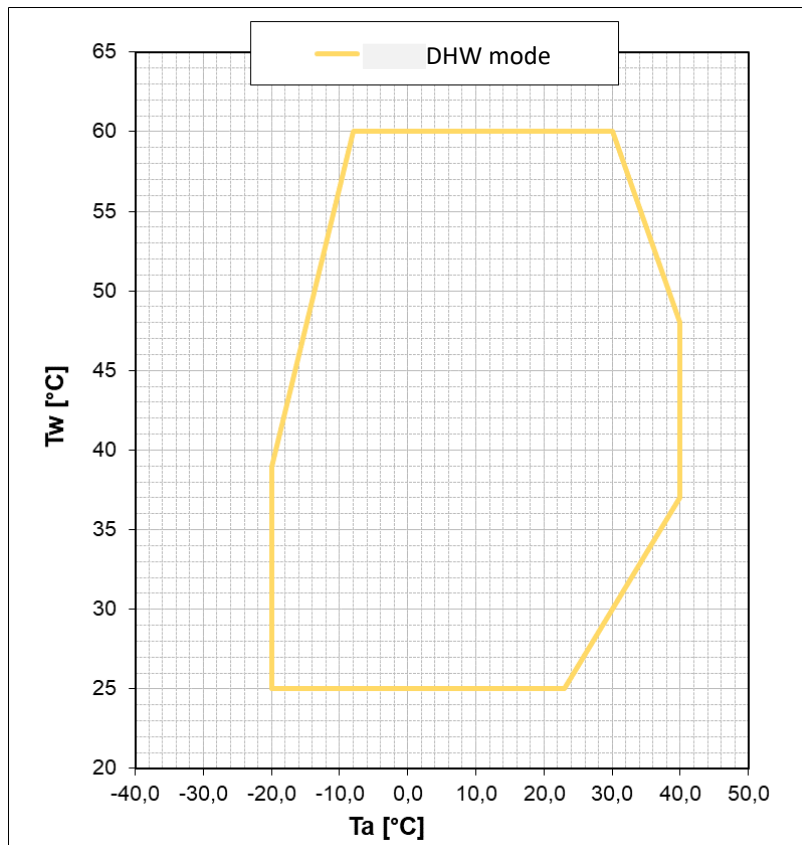

13 USER INTERFACE - CONTROLLER

The unit includes a display placed underneath a hinged polycarbonate transparent door with a protection rating of IP67.

The interface has a part with variable text and a series of icons identifying operation of the unit as shown in the table below.

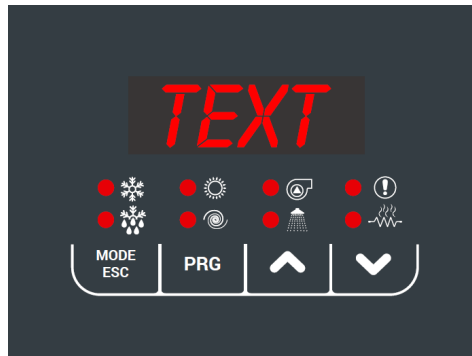

	Cooling mode led: led ON if unit is in COOL or COOL+SAN mode.
	Heating mode led: led ON if unit is in HEAT or HEAT+SAN mode.
	Pump led ON if pump running.
	Alarm led: led ON if an alarm is triggered.
	Defrost led: led ON if defrosting enabled, OFF if defrosting disabled or finished, FLASHING if defrosting time interval count in progress.
	Compressor led: led ON if the compressor is running, OFF if the compressor is off, FLASHING if pending the timed compressor start.
	Domestic hot water led: led ON if COOL+SAN or HEAT+SAN mode enabled, OFF if sanitary mode disabled, FLASHING if DHW production in progress.
	Antifreeze heater led: led ON if antifreeze heater on.

The buttons have the specific function described below

	Select the operating mode and manually reset any alarms. Each time you press the key you have the following sequence: off → cool → heat → off If DHW is enabled, the sequence is the following: off → cool → cool+san → heat → heat+san → off While setting the parameters, this key has the function of sending BACK by one level.
	Grants access to the parameter-setting menu and allows you to set the summer, winter and sanitary setpoint.
	UP key. In the parameter setting mode, it allows you to move to a higher menu or to increase the parameter value
	DOWN key. In the parameter setting mode, it allows you to move to a lower menu or to decrease the parameter value

In standard operation, the display shows the water outlet temperature in tenths of Celsius degrees or the alarm code if at least one is active. If several alarms are triggered, the first one is displayed while the second one will be displayed as soon as the first one is reset. In menu mode, the display depends on the current position

13.1 MENU

The following are the main features for navigating the menus, especially describing functions which are not obvious. The main menu has the following items:

MENU	LABEL	PASSWORD LEVEL	OTHER CONDITIONS
Setpoint	Set	User	Not accessible if connected to Hi-t2
Probes	tP	Installer	---
Alarms	Err	User	Only if active alarms
Digital inputs	Id	Installer	---
Parameters	Par	Installer	---
Password	PSS	User	---
Hours of operation	oHr	Installer	---
USB	USb	Installer	Only with pen drive with relevant update files
Firmware Version	Fir	Installer	Version, Revision and Sub
Alarm log	Hist	Installer	Only if the log contains data

The PSS menu is accessed to enter the service password and to enable access with a higher user permission. When you have exited the menus, the password must be entered once again to re-enter.

13.2 SETPOINT MENU

The various setpoint can be viewed and edited.

SETPOINT	DESCRIPTION	UNIT	DEFAULT	RANGE
Coo	First Summer setpoint	°C	7.0	5 - Co2
Hea	First Winter setpoint	°C	45.0	25 - 60
*San	Sanitary setpoint	°C	48.0	25 - 60
Coo2	Second Summer setpoint	°C	18.0	Coo - 25
Hea2	Second Winter setpoint	°C	35.0	25- Hea

(*) If the DHW function is enabled

13.3 ALARMS MENU [Err]

This menu is only displayed if there are triggered alarms. All of the active alarms can be seen. This is a multi-circuit machine. Therefore all the alarms are divided by circuit (label ALCx grants access to the alarms of circuit number x).

Viessmann Limited
Hortonwood 30, Telfort
Shropshire , TF1 7YP, GB
Telephone: +44 1951675000
Fax: +44 1952 675040
E-mail: info-uk@viessmann.com